

User Manual



371B
Programmable
High Power Curve Tracer
070-A840-00

Copyright © Sony/Tektronix Corporation. All rights reserved.

Copyright © Tektronix, Inc. All rights reserved.

Tektronix products are covered by U.S. and foreign patents, issued and pending. Information in this publication supercedes that in all previously published material. Specifications and price change privileges reserved.

Printed in Japan.

Sony/Tektronix Corporation, 5-9-31 Kitashinagawa, Shinagawa-ku, Tokyo 141-0001 Japan

Tektronix, Inc., P.O. Box 500, Beaverton, OR 97077

TEKTRONIX and TEK are registered trademarks of Tektronix, Inc.

WARRANTY

Tektronix warrants that the products that it manufactures and sells will be free from defects in materials and workmanship for a period of one (1) year from the date of shipment. If a product proves defective during this warranty period, Tektronix, at its option, either will repair the defective product without charge for parts and labor, or will provide a replacement in exchange for the defective product.

In order to obtain service under this warranty, Customer must notify Tektronix of the defect before the expiration of the warranty period and make suitable arrangements for the performance of service. Customer shall be responsible for packaging and shipping the defective product to the service center designated by Tektronix, with shipping charges prepaid. Tektronix shall pay for the return of the product to Customer if the shipment is to a location within the country in which the Tektronix service center is located. Customer shall be responsible for paying all shipping charges, duties, taxes, and any other charges for products returned to any other locations.

This warranty shall not apply to any defect, failure or damage caused by improper use or improper or inadequate maintenance and care. Tektronix shall not be obligated to furnish service under this warranty a) to repair damage resulting from attempts by personnel other than Tektronix representatives to install, repair or service the product; b) to repair damage resulting from improper use or connection to incompatible equipment; c) to repair any damage or malfunction caused by the use of non-Tektronix supplies; or d) to service a product that has been modified or integrated with other products when the effect of such modification or integration increases the time or difficulty of servicing the product.

THIS WARRANTY IS GIVEN BY TEKTRONIX IN LIEU OF ANY OTHER WARRANTIES, EXPRESS OR IMPLIED. TEKTRONIX AND ITS VENDORS DISCLAIM ANY IMPLIED WARRANTIES OF MERCHANTABILITY OR FITNESS FOR A PARTICULAR PURPOSE. TEKTRONIX' RESPONSIBILITY TO REPAIR OR REPLACE DEFECTIVE PRODUCTS IS THE SOLE AND EXCLUSIVE REMEDY PROVIDED TO THE CUSTOMER FOR BREACH OF THIS WARRANTY. TEKTRONIX AND ITS VENDORS WILL NOT BE LIABLE FOR ANY INDIRECT, SPECIAL, INCIDENTAL, OR CONSEQUENTIAL DAMAGES IRRESPECTIVE OF WHETHER TEKTRONIX OR THE VENDOR HAS ADVANCE NOTICE OF THE POSSIBILITY OF SUCH DAMAGES.

Contacting Tektronix

Phone	1-800-833-9200*
Address	Tektronix, Inc. Department or name (if known) 14200 SW Karl Braun Drive P.O. Box 500 Beaverton, OR 97077 USA
Web site	www.tektronix.com
Sales support	1-800-833-9200, select option 1*
Service support	1-800-833-9200, select option 2*
Technical support	Email: techsupport@tektronix.com 1-800-833-9200, select option 3* 1-503-627-2400 6:00 a.m. – 5:00 p.m. Pacific time

* **This phone number is toll free in North America. After office hours, please leave a voice mail message.**
Outside North America, contact a Tektronix sales office or distributor; see the Tektronix web site for a list of offices.

Manual Revision Status

371B User Manual revision status.

REV	OS/Program Version	Manual P/N	DESCRIPTION
R01		070A84000	App.C Message

Contact Tektronix for detailed information about the 371B version status.

Table of Contents

	General Safety Summary	ix
Getting Started		
	Product Description	1-1
	Measurement Concepts	1-5
	Installation	1-6
	Repacking for Shipment	1-13
Controls, Indicators and Connectors		
	Controls, Indicators, and Connectors	2-1
	Instrument Power and CRT Controls	2-2
	Setup, Memory Index, and Measurement Controls	2-4
	Display Controls	2-7
	Cursor Controls	2-11
	Step Generator Controls	2-14
	Collector Supply Controls	2-17
	GPIB Controls and Floppy Disk Drive	2-19
	Signal Output Controls, Indicators and Connectors	2-21
	Rear Panel	2-23
	Test Fixture Unit and Panel Connectors	2-25
	Readout Display	2-28
	Operating Basics	2-31
	Device Connection	2-32
	Test Fixture Interlock	2-35
	Device Stimulus	2-37
	Data Acquisition	2-39
	Measurement Modes	2-39
	Device Characteristics Display	2-42
	Display Modes	2-45
	Display Cursors	2-47
	Text Editing	2-48
	Memory and Mass Storage	2-50
	Disk Formatting	2-57
	Floppy Disk Handling	2-58

Reference

Reference	3-1
Operating Exercises	3-2
Powering-Up the 371B and Storing Power-Up Default Settings	3-3
Exercising the Display Controls	3-4
Setting Date and Time	3-5
Checking the Calibration Reference Voltage and Display Invert Feature ..	3-6
Exercising Setup Save and Recall Features	3-7
Exercising Vertical and Horizontal Sensitivity Controls	3-8
Exercising Text Editing Feature	3-11
Formatting Floppy Disks	3-12
Verifying Floppy Disk Operation	3-13
Displaying the Memory Directory	3-14
Erasing Non-Volatile Memory	3-14
Hardcopy and Save the CRT Image	3-15
Measurement Exercises	3-17
Effects On Device Characteristics	3-17
Guidelines for Using Measurement Exercises	3-17
Saving the Initial (Default) Setup	3-18
Diode Measurement Exercises	3-18
Bipolar Transistor Measurement Exercises	3-25
Power MOSFET Measurement Exercises	3-37

GPIB

GPIB	4-1
Review	4-2
Interface Capabilities	4-7
Setup	4-11
Controlling the 371B over the bus	4-15
Device-Dependent Message Format	4-24
371B GPIB Commands	4-30
Command Reference	4-33
Service Requests	4-100

Appendices

Appendix A: Specification	A-1
Appendix B: Options and Accessories	B-1
Options	B-1
Accessories	B-2
Appendix C: Diagnostic Routines and Messages	C-1
Diagnostic Routines	C-1
Messages	C-7
Appendix D: Inspection and Cleaning	D-1

Index

List of Figures

Figure 1–1: DUT connection path when using adapter and patch panels	1–4
Figure 1–2: Basic 371B block diagram	1–5
Figure 1–3: Location of the LINE VOLTAGE INDICATOR	1–8
Figure 1–4: Connecting the Test Fixture Unit to the 371B	1–11
Figure 2–1: Instrument power and display controls	2–2
Figure 2–2: Setup, Memory Index, and Measurement controls	2–4
Figure 2–3: Display Controls	2–7
Figure 2–4: Cursor Controls	2–11
Figure 2–5: Step Generator controls	2–14
Figure 2–6: Collector Supply controls	2–17
Figure 2–7: GPIB controls and Floppy Disk Drive	2–19
Figure 2–8: Signal output controls, indicators, and connectors	2–21
Figure 2–9: Rear panel controls and connectors	2–23
Figure 2–10: Test fixture unit connectors	2–25
Figure 2–11: Display Screen	2–28
Figure 2–12: DUT connection path when using adapter panel and test adapters	2–32
Figure 2–13: Test adapter pin configuration	2–34
Figure 2–14: Internal wiring (signal path) of adapter panel	2–34
Figure 2–15: Removing the adapter panel	2–36
Figure 2–16: Connecting a device directly to the test fixture unit using patch cords	2–36
Figure 2–17: Display screen and its display areas	2–43
Figure 2–18: 371B memory structure	2–51
Figure 2–19: Sample directory display	2–52
Figure 3–1: Patch cord connections for vertical and horizontal sensitivity exercise	3–9
Figure 3–2: The floppy disk write-protect tab	3–13
Figure 3–3: Inserting a floppy disk	3–13
Figure 3–4: Adapter panel and patch panel connections for measuring diode forward resistance	3–19
Figure 3–5: Sweep mode display of the forward characteristics of a diode	3–20

Figure 3–6: Using f line cursor to measure forward resistance of a diode	3–21
Figure 3–7: Adapter panel and patch panel connection for measuring diode breakdown voltage	3–23
Figure 3–8: Diode breakdown voltage and current level	3–25
Figure 3–9: Adapter panel and patch panel connections for measuring bipolar transistor characteristics	3–27
Figure 3–10: Collector current versus collector/emitter voltage characteristic curve	3–28
Figure 3–11: Using the window cursor to calculate hfe of a bipolar transistor	3–31
Figure 3–12: VCE (saturation) curve for a bipolar transistor	3–33
Figure 3–13: Adapter panel and patch panel connections for measuring breakdown voltage characteristics of a bipolar transistor	3–34
Figure 3–14: Display of the BVCEO and BVCES breakdown measurements with reference function	3–36
Figure 3–15: Adapter panel and patch panel connections for measuring power MOSFET characteristics	3–38
Figure 3–16: Drain current versus drain/source voltage characteristics for a power MOSFET	3–41
Figure 3–17: Drain current versus drain/source voltage characteristics for 10 steps with the reference display	3–42
Figure 3–18: Forward transfer curve, ID = 8 A	3–43
Figure 3–19: Using the f line cursor to measure forward transfer admittance of a power MOSFET. In this example. Gfs = 6.722 S	3–44
Figure 4–1: GPIB messages	4–4
Figure 4–2: GPIB message types	4–5
Figure 4–3: Rear panel configuration switch	4–11
Figure 4–4: Bus configurations	4–13
Figure 4–5: Transfer of settings	4–18
Figure 4–6: Data transfer under GPIB control	4–20
Figure 4–7: Transfer of waveforms	4–22
Figure C–1: Display quality test pattern	C–3

List of Tables

Table 1–1: Line voltage ranges	1–7
Table 1–2: Power cord identification	1–9
Table 2–1: Vertical Axis Sensitivity Settings	2–9
Table 2–2: Display Sensitivity Selections	2–10
Table 2–3: Alternate Functions Controlled by the SHIFT Button ...	2–13
Table 2–4: Test Adapter Voltage Ratings	2–33
Table 2–5: Controls that do not defeat Sweep Mode	2–42
Table 2–6: Vertical Axis Display Settings	2–44
Table 2–7: Horizontal Sensitivity Ranges	2–45
Table 2–8: Relationships between Cursors and Readout display	2–47
Table 2–9: Summary of Text Editing Functions	2–50
Table 2–10: Controls that cannot be stored in Mass Storage	2–54
Table 3–1: Default Setup	3–4
Table 3–2: Display Area Readout at Power-Up	3–5
Table 3–3: Bipolar Transistor/MOSFET Characteristics Comparison	3–37
Table 4–1: GPIB Interface Specifications	4–7
Table 4–2: Controller Output Syntax	4–16
Table 4–3: Controller Input Syntax	4–17
Table 4–4: Numeric Argument Formats	4–27
Table 4–5: Argument Format Examples	4–27
Table 4–6: GPIB Commands and Queries for Front-Panel Controls	4–30
Table 4–7: General Setting Information and Related GPIB Commands	4–32
Table 4–8: Command and Query Groups	4–33
Table 4–9: Status Byte Responses	4–102
Table 4–10: Status Byte and Event Code	4–103
Table A–1: Collector Supply Electrical Specification	A–1
Table A–2: Step Generator	A–3
Table A–3: Vertical Deflection System	A–6
Table A–4: Horizontal Deflection System	A–6
Table A–5: Digital Storage Acquisition	A–6

Table A-6: CRT and Readout	A-8
Table A-7: Power Requirements	A-9
Table A-8: Power Source	A-9
Table A-9: Physical Specification	A-9
Table A-10: Surge Current	A-9
Table A-11: Cooling Clearance	A-10
Table A-12: Environmental Specification	A-10
Table A-13: Certifications and Compliances	A-12
Table A-14: Installation category and Pollution degree Descriptions	A-13
Table A-15: Text Display	A-14
Table B-1: Standard accessories	B-2
Table B-2: Optional accessories	B-2
Table B-3: Recommended accessories	B-3
Table C-1: Power-on System Error Messages	C-4
Table C-2: Front Panel Control Identification	C-4
Table C-3: Messages	C-7
Table D-1: External inspection check list	D-1

General Safety Summary

Review the following safety precautions to avoid injury and prevent damage to this product or any products connected to it. To avoid potential hazards, use this product only as specified.

Only qualified personnel should perform service procedures.

To Avoid Fire or Personal Injury

Use Proper Power Cord. Use only the power cord specified for this product and certified for the country of use.

Ground the Product. This product is grounded through the grounding conductor of the power cord. To avoid electric shock, the grounding conductor must be connected to earth ground. Before making connections to the input or output terminals of the product, ensure that the product is properly grounded.

Observe All Terminal Ratings. To avoid fire or shock hazard, observe all ratings and markings on the product. Consult the product manual for further ratings information before making connections to the product.

The common terminal is at ground potential. Do not connect the common terminal to elevated voltages.

Do not apply a potential to any terminal, including the common terminal, that exceeds the maximum rating of that terminal.

Do Not Operate Without Covers. Do not operate this product with covers or panels removed.

Use Proper Fuse. Use only the fuse type and rating specified for this product.

Avoid Exposed Circuitry. Do not touch exposed connections and components when power is present.

Do Not Operate With Suspected Failures. If you suspect there is damage to this product, have it inspected by qualified service personnel.

Do Not Operate in Wet/Damp Conditions.

Do Not Operate in an Explosive Atmosphere.

Keep Product Surfaces Clean and Dry.

Provide Proper Ventilation. Refer to the manual's installation instructions for details on installing the product so it has proper ventilation.

Symbols and Terms

Terms in this Manual. These terms may appear in this manual:



WARNING. *Warning statements identify conditions or practices that could result in injury or loss of life.*



CAUTION. *Caution statements identify conditions or practices that could result in damage to this product or other property.*

Terms on the Product. These terms may appear on the product:

DANGER indicates an injury hazard immediately accessible as you read the marking.

WARNING indicates an injury hazard not immediately accessible as you read the marking.

CAUTION indicates a hazard to property including the product.

Symbols on the Product. The following symbols may appear on the product:



WARNING
High Voltage



Protective Ground
(Earth) Terminal



CAUTION
Refer to Manual



Double
Insulated



Getting Started

Getting Started

This section provides the following information:

- Description and features of the 371B Programmable High Power Curve Tracer.
- Measurement concept
- Initial inspection procedure
- Installation procedures
- Repackaging procedure for shipment

Product Description

The 371B Programmable High Power Curve Tracer provides both high current and high voltage for testing high-power semiconductor devices at user-selected power settings. It can test devices at up to 400 amps at power levels up to 3000 watts. By measuring and displaying the characteristics on a CRT screen, the 371B enables a user to analyze and evaluate the static characteristics of semiconductor devices.

Non-volatile memory (RAM) and floppy disk storage enable you to store frequently used test setups and curve characteristics for quick and easy measurement comparisons. Using memory in this way helps you avoid errors associated with manual testing, and allows you to run more repetitive-type tests in any given period. You can store up to 64 characteristic curves and 64 setups on a floppy disk, and up to 16 characteristic curves and 16 setups in non-volatile memory. Stored characteristic curves and setups can be recalled for additional analysis and comparison.

The 371B provides direct readout on the CRT of offset base/gate voltage or current. The 371B calculates these values for you, unlike earlier curve tracers where these functions had to be calculated manually.

The 371B also has the ability to average readings to reduce the effects of random noise, which can obscure actual curve data.

The rear panel contains a GPIB connector. The GPIB connector is for use by a GPIB-compatible controller or other GPIB instrumentation. Using this connector and appropriate GPIB instruments, you can create and control tests to suit your application. A typical GPIB system will include a controller and one or more instruments, such as the 371B, a signal generator, a digital multimeter, and a digital oscilloscope. Some GPIB instruments are talk only or listen only devices while others can both talk and listen. The 371B does both. Linking a controller to the 371B, and possibly other instruments, provides operation in four major task areas:

- Program development
- System control
- Data processing
- Display and storage

Rackmount Capability

The 371B can be mounted in a standard electrical equipment rack using Tektronix-supplied rackmount hardware. Refer to page B-2 for optional accessories.

371B Components

The 371B consists of two large components: a main unit and a test fixture unit.

Main Unit

The main unit contains front and rear panel controls, indicators and connectors, a display CRT, and the control electronics.

Front and Rear Panels. To use the 371B effectively, you need a clear understanding of the functions and meanings of the operator controls, indicators and connectors mounted on the front and rear panels. Detailed descriptions are provided in Chapter 4: Controls, Indicators, and Connectors.

The CRT functions as the display device. It has 10 x 10 graticule markings etched into its inner surface, the brightness of which can be controlled by the front-panel GRAT ILLUM (graticule illumination) control. A filter mounted on the front of the CRT improves display contrast.

The readout area of the display (which also displays setup information) is divided into two parts:

- The readout labels which identify the readout information printed in the readout area
- The readout information which identifies either a specific control setting (such as 1 A or 1 V), or a measured characteristic of the device under test (DUT)

Refer to page 2–28 for detailed information about each readout area.

Readout intensity is controlled by the READOUT/CURSOR knob; label intensity is controlled by the GRAT ILLUM knob.

NOTE. *The READOUT/CURSOR control also controls the intensity of other information displayed on the screen, which may include text, messages, and setup and curve identification.*

Refer to page 2–1 for a detailed description of this information.

Test Fixture Unit. All tests are made with the semiconductor device mounted inside the test fixture unit. The test fixture unit connects to the front panel of the main unit (as shown in the frontispiece illustration opposite page 1–1).

The test fixture unit contains a patch panel and an adapter panel that are enclosed by a clear plastic cover during the actual testing process. The DUT connects to the patch panel in one of two ways.

- Using test adapters. Test adapters are used to connect common semiconductor devices to the adapter panel, which in turn is connected to the patch panel using patch cords. This technique is shown in Figure 1–1.
- Using patch cords. Devices that cannot be connected using test adapters can be connected to the patch panel using patch cords with clips. In such cases, the adapter panel may have to be removed. Refer to page 1–11 how to remove the adapter panel.

The test fixture connects to the main unit using the interconnect cable and connector. The top row of connectors on the patch panel are linked internally to the connector cable.

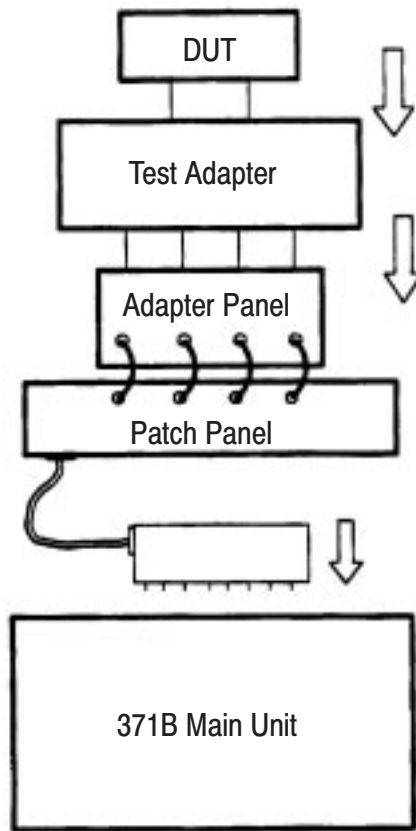

Figure 1-1: DUT connection path when using adapter and patch panels

Test Fixture Interlock

The test fixture unit is provided with a safety interlock system. Whenever the test fixture cover is in the raised position, the collector supply voltage is disabled and you can safely connect and disconnect devices at the patch panel and the adapter panel. When the cover is closed the collector supply voltage is enabled. The enabled state is indicated by a red WARNING indicator on the 371B. When lit, the WARNING indicator indicates that the collector supply is enabled and that a dangerous voltage may appear at the patch panel terminals on the test fixture unit.



WARNING. Do not disable the safety interlock system and then attempt to operate the 371B. You may accidentally contact high voltage and serious personal injury or death may result.

The collector supply is also disabled whenever the test fixture unit cable is disconnected from its connector at the front panel of the main unit.

Measurement Concepts

The 371B consists of a specially-designed CRT screen and associated electronics that allow a user to display the characteristics of a semiconductor device. The display screen is designed to display the operating characteristics of the DUT in an easy-to-read, standard graph form.

The 371B can be applied to a broad range of semiconductor test application, such as:

- Semiconductor design analysis
- Semiconductor failure analysis
- Incoming inspection of semiconductors
- Comparison of semiconductor device characteristics
- Semiconductor manufacturing output

Figure 1–2 helps to illustrate 371B measurement concepts. A collector supply and step generator circuits apply voltage or current to the DUT. A detector amplifier measures the resulting effect. Measurement results are displayed on a CRT as one or more characteristic curves.

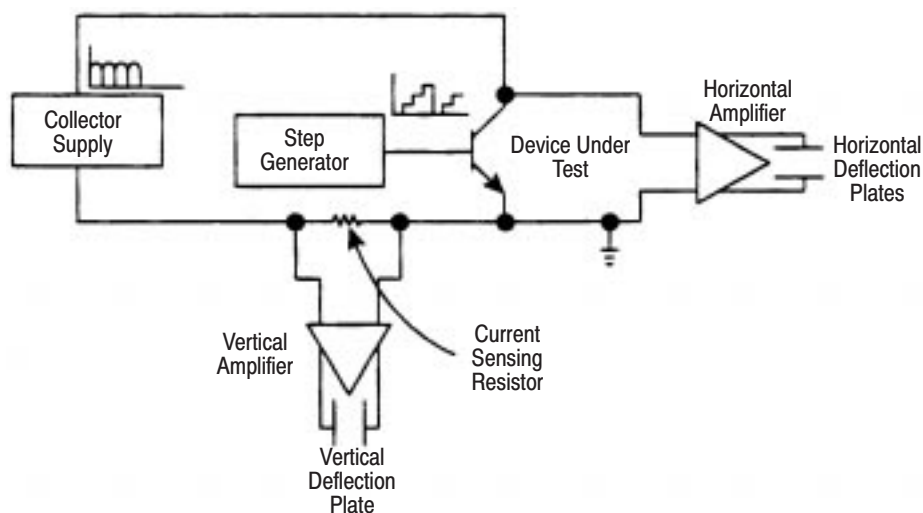

Figure 1-2: Basic 371B block diagram

Collector Supply

The collector supply provides a swept or pulsed voltage to the DUT. Amplitude is controlled by the collector supply VARIABLE knob. This signal is applied to the collector (drain, anode, or equivalent terminal) of the DUT.

Step Generator

The step generator supplies one voltage or current step, or pulse, for each collector supply sweep or pulse. The amplitude of the voltage or current is set by the STEP/OFFSET AMPLITUDE knob and the number of steps by the NUMBER OF STEPS selection buttons. The signal from the step generator can be applied to the base or emitter (or an equivalent terminal) of the DUT.

Detector Amplifier

The detector amplifiers are connected to the DUT to measure the effect of the stimulus signals from the collector supply and the step generator. The measurement result is amplified and the voltage obtained is applied to the CRT deflection plates. Sensitivity of the amplifier is set by the VERTICAL CURRENT/DIV (vertical current per division) and HORIZONTAL VOLTS/DIV (horizontal volts per division) knobs.

Installation



WARNING. *The 371B Programmable High Power Curve Tracer weighs approximately 36 kg (80 lb). It requires two people to lift the instrument out of its shipping carton. Work carefully to avoid injury due to improper lifting.*

The CRT can implode if it or the 371B is handled severely. When handling the 371B always be aware of and practice safe work habits. If damaged, the CRT could implode resulting in serious personal injury

Initial Inspection

All shipping containers and internal packing material should be saved for reuse. Perform the following to unpack the 371B from its shipping container and to perform initial inspection.

1. Remove the securing bands holding the outer lid on the shipping container.
2. Lift the lid off the shipping container.
3. Remove the accessory box from the carton. Set this box aside to be unpacked later.
4. Carefully lift the 371B and the test fixture unit out of the shipping container and place them on a flat, sturdy surface.



CAUTION. *DO NOT apply power at this time otherwise severe instrument damage may occur.*

5. Thoroughly inspect the 371B for mechanical and electrical defects that may have occurred during shipment. If the instrument has been damaged in shipment, first contact the shipping company and then contact your nearest Tektronix field representative.

Checking Standard Accessories

Standard accessories are shipped with your 371B. Open the accessories package you removed when unpacking the instrument, and verify its contents against the list of standard accessories on page B-2. If there are any discrepancies, contact your nearest Tektronix field representative.

Line Voltage Requirements

This instrument operates from a single-phase power source having a neutral at or near ground (earth) potential. It is not intended for operation from two phases of a multi-phase system, nor across legs of a single-phase, three-wire system. This instrument can be operated from either a 100 V, 120 V, 200 V, or 240 V nominal supply source of 48 Hz to 63 Hz. Table 1-1 provides a listing of line voltage ranges, line frequency range, and power consumption. The line voltage setting of the instrument is indicated by a screw on the rear panel (shown in Figure 1-3).

Table 1-1: Line voltage ranges

Line Voltage		Fuses	
Nominal	Range	Main	Collector
240 V	216 V to 250 V	250 V, 1 A Slow blow	250 V, 2 A Slow blow
200 V	180 V to 220 V		
120 V	108 V to 132 V	250 V, 2 A Slow blow	250 V, 4 A, Slow blow
100 V	90 V to 110 V		
Line Frequency	48 Hz to 63 Hz		
Maximum Power	400 W, 4.5 A		

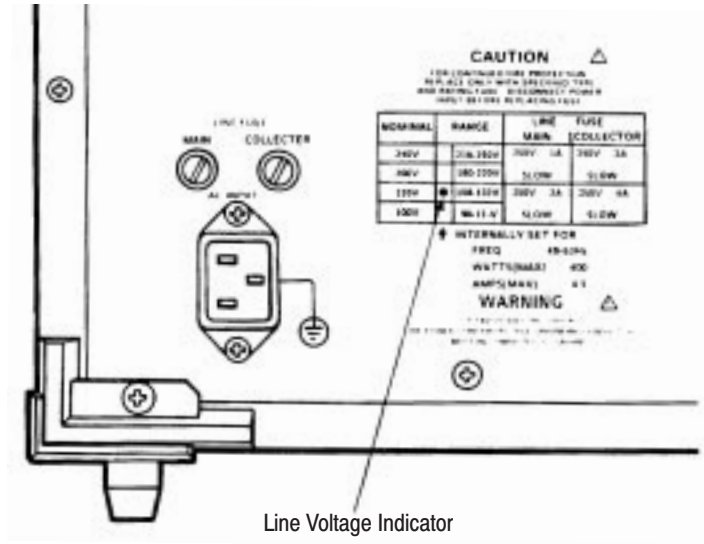

Figure 1-3: Location of the LINE VOLTAGE INDICATOR



CAUTION. To prevent damage to the instrument, check the position of the **LINE VOLTAGE INDICATOR** located on the rear panel of the 371B before connecting the instrument to a line voltage source. Also, check to ensure that the proper line fuses are installed for the main and collector power supplies.

If the **LINE VOLTAGE INDICATOR** indicates that the 371B is configured to operate at a voltage other than that available at the user's site, contact your local Tektronix field representative, or refer a qualified service technician.

Table 1-2: Power cord identification

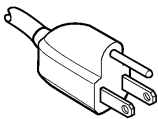
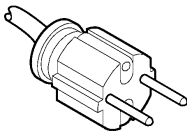
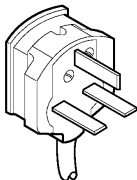
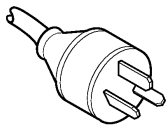
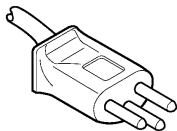
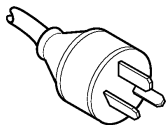
Plug configuration	Normal usage	Option number
	North America 125 V	Standard
	Europe 220 V	A1
	United Kingdom 240 V	A2
	Australia 240 V	A3
	Switzerland 220 V	A5
	C4ina 240 V	AC
	No power cord supplied.	A9



WARNING. *This instrument operates from a single-phase power source, and has a detachable three-wire power cord with a two-pole, three-terminal grounding plug. The voltage to ground (earth) from either pole of the power source must not exceed the maximum rated operating voltage (250 Vrms).*

Before making connection to the power source, make sure that the instrument is set for the power source voltage, and is equipped with a suitable plug (two-pole, three-terminal, with ground).

This instrument is IEC Safety Class 1 equipment. All accessible conductive parts are directly connected through the grounding conductor of the power cord to the grounding contact of the power plug. Therefore, the power plug must only be inserted in a mating receptacle with a grounding contact. Do not defeat the grounding connection. Any interruption of the grounding connection can create an electric shock hazard.

Refer to Table 1–2 if a power cord other than the one supplied is required.

Operating Temperature and Cooling

The 371B can be operated where the ambient temperature is between +10°C and +40°C. After storage at temperatures outside the operating limits, allow the chassis temperature to reach the safe operating limits before applying power.

The instrument is cooled by air drawn in through the air filter on the rear panel and blown out through holes in the side panels. For proper instrument cooling, provide adequate clearance of at least two inches on the rear and sides to ensure free air flow and dissipation of heat away from the unit.



CAUTION. *Prolonged use of the 371B can cause high temperatures which may damage the instrument or DUT. When applying current in the 3 kW range of the peak power watts selector, test time should be limited to four minutes, followed by at least 11 minutes of cooling.*



WARNING. *Prolonged use of the 371B at high power settings can make the device under test, test fixture unit, or protective cover hot enough to cause injury. Avoid touching any of these areas until cooled.*

Connecting the Test Fixture Unit

Before powering-up the 371B, connect it to the test fixture unit as shown in Figure 1-4. Device measurements are performed using the test fixture with its adapter panel, patch panel, and patch cords.

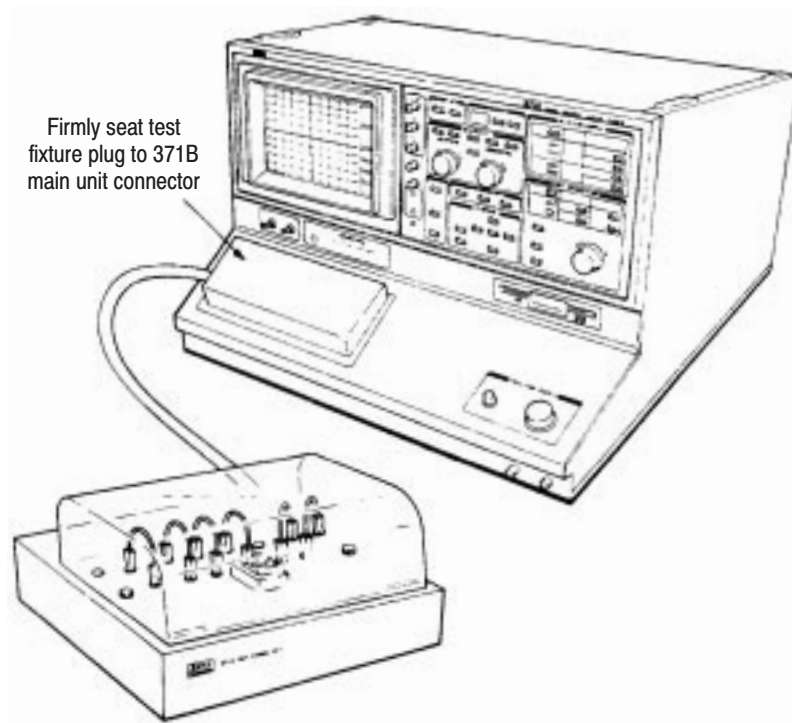

Figure 1-4: Connecting the Test Fixture Unit to the 371B



CAUTION. When inserting the test fixture unit plug into its connector on the 371B, be certain the plug is parallel to the connector surface so that the connecting pins will be inserted straight into the connector; otherwise the connector and its pins could be damaged.

Test Fixture Interlock. The 371B main unit/test fixture system is provided with a safety interlock system that disables the collector supply at the patch panel terminals on the test fixture unit. Whenever the patch panel cover is in the raised position, the collector supply voltage is disabled and you can safely connect/disconnect devices at the patch panel. When the safety cover is closed, the collector supply voltage is enabled. The enabled state is indicated by a red WARNING indicator on the 371B. When lit, the WARNING indicator cautions the user that the collector supply is enabled and that a dangerous voltage may appear at the patch panel terminals on the test fixture unit.

The collector supply is also disabled whenever the test fixture unit cable is disconnected from its connector at the front panel of the main unit.

Performing Power-up and First-time Operating Exercises

After you have ensured that the 371B is connected to the appropriate line voltage and the test fixture unit is properly connected to the main unit, you are ready to power-up the instrument and verify its operation. Refer to the following information located elsewhere in this manual.

- *Device Connection* on page 2–32.
- *First Time Operating Exercises* on page 3–2.
- *Measurement Exercises* on page 3–17.

Repacking for Shipment

If you must ship the 371B long distances, we recommend that you repackage the instrument the same as when it initially arrived at your site. The cartons and packaging material in which the instrument was shipped should be saved and used for this purpose.

If the instrument is shipped to a Tektronix service center for service or repair, attach a tag to the instrument showing the following information:

- Owner of the instrument (with address)
- Name of a person at your firm to contact
- Instrument type and instrument serial number
- Description of the service requested

If the original packaging is unfit for use or not available, package the instrument as follows:

1. Obtain a corrugated cardboard shipping carton with a 375 lb test strength and inside dimensions at least six inches greater than the instrument dimensions.
2. Surround the instrument with polyethylene sheeting to protect the finish.
3. Cushion the instrument on all sides by tightly packing dunnage or urethane foam between the carton and the instrument, placing at least three inches of dunnage on all sides.
4. Seal the carton with shipping tape or with an industrial stapler.
5. Write the address of the Tektronix service center and your return address on the carton in one or more prominent locations.



Controls, Indicators and Connectors

Controls, Indicators, and Connectors

To use the 371B features efficiently you need a clear understanding of the functions and meanings of its controls, indicators, connectors, and readout display areas.

This chapter contains a detailed description of the following:

- Describes the function of all controls, indicators, and connectors on the front panel, rear panel, and test fixture unit of the 371B.
- Provides illustrations to help locate front panel, rear panel, and test fixture unit items.
- Describes the display areas on the 371B CRT.

The controls, indicators, and connectors for the 371B are located on the front and rear panels. The connectors for the device under test (DUT) are located on the patch panel and the adapter panel of the test fixture unit. Setup status and measurement results are indicated in readout areas on the CRT display.

The controls, indicators, connectors, and readout displays are shown and identified in Figures 2–1 through 2–11. The location on the 371B of a specific set of controls is indicated by a black overlay on the control illustration. The descriptions in this section are preceded by index numbers that match the numbers on the illustrations. Control descriptions are presented in numerical order.

Use this section as a reference when you want to know the exact operation and function(s) of a switch, indicator, connector, or readout display area. Refer to page 2–31 for a general explanation of how the 371B operates. Refer to page 3–2 for specific demonstrations of the controls as they are actually used to perform semiconductor device measurements.

Instrument Power and CRT Controls

Figure 2-1 shows the location of these controls on the front-panel.

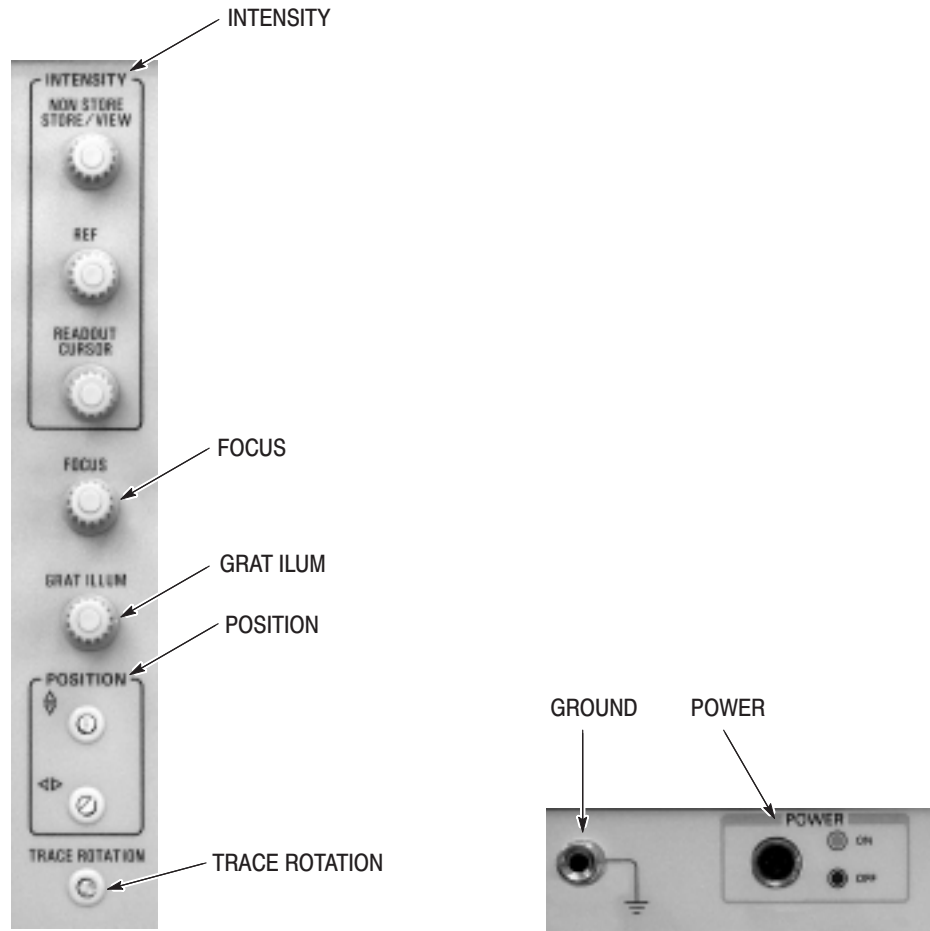

Figure 2-1: Instrument power and display controls

POWER. The POWER switch connects the 371B to its power source. Press the switch to connect the 371B to its power source; press the switch again to disconnect the 371B from its power source.

GROUND CONNECTOR. The front-panel ground connector, located beside the POWER switch, is used to connect the 371B to an external ground level, wrist strap, and any other item that may require grounding.

INTENSITY. There are three intensity controls:

NON STORE/STORE/VIEW

The NON STORE/STORE/VIEW intensity knob controls the waveform display intensity in the non store, store, or view modes, respectively.

REF (Reference)

The REF intensity knob controls the intensity of the reference waveform display.

READOUT/CURSOR

The READOUT/CURSOR intensity knob controls the intensity of the readout text, the f line cursor, and the window cursor.

FOCUS. The FOCUS knob controls the focus of the CRT display.

GRAT ILLUM (Graticule Illumination). The GRAT ILLUM knob controls the illumination level (brightness) of the CRT graticule.

POSITION. The POSITION screwdriver adjustments control the vertical and horizontal position of display information.

TRACE ROTATION. The TRACE ROTATION screwdriver adjustment adjusts the slant of the display information in reference to the graticule.

Setup, Memory Index, and Measurement Controls

Control locations are shown in Figure 2–2.

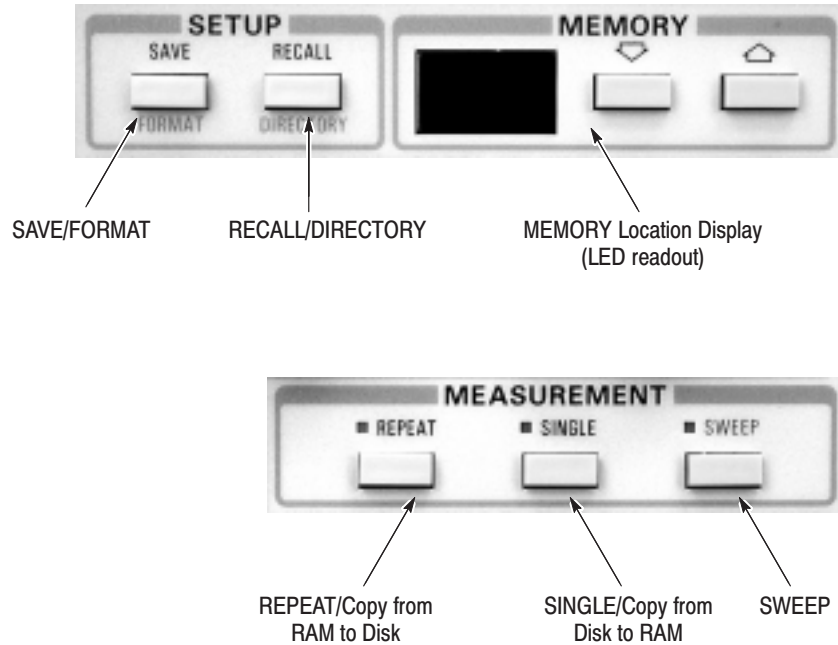

Figure 2–2: Setup, Memory Index, and Measurement controls

SAVE/FORMAT. This button has two functions:

- Press the **SAVE** button to save the front-panel setup in memory at the user-selected memory index location.
- Hold down the cursor **SHIFT** button and then pressing the **SAVE** button, to initiate formatting a floppy disk.

RECALL/DIRECTORY. This button has two functions:

- Press the **RECALL** button to recall a previously-stored group of 371B front-panel settings (setups). The 371B controls are then set to the front-panel settings read from the selected memory index location.
- Hold down the cursor **SHIFT** button and press the **RECALL** button to display the first page of a directory of the contents of mass storage (contents of both non-volatile memory and floppy disk). Use the memory up and down buttons to “page” through the directory.

MEMORY Location Display (LED readout). This two-digit LED display has two functions:

- It indicates the memory location to or from which front-panel setups and characteristic curves will be stored or read, respectively. Such indications occur when performing enter, save, recall, or view functions.
- When in directory display mode, it indicates the number of the directory page currently being displayed.

You move up or down through memory locations and directory pages using the memory up and down buttons. When you hold down the cursor SHIFT button while pressing the memory up or down button, the rate of change increases.

Simultaneously pressing the memory up and down buttons sets the memory location (or directory page) number to 1.

REPEAT/Copy from RAM to Disk. This button has two functions:

- Press the REPEAT button to cause the 371B to generate repetitive base and collector pulses. In this way the measurement is performed repeatedly.
- When you hold down the cursor SHIFT button and press the REPEAT button, the function of this button changes to COPY from non-volatile memory to disk. (Note that this function name is not silkscreened below the button.) The copy function can be used to simultaneously copy up to 16 characteristic curves and 16 front-panel setups from non-volatile memory to floppy disk. For additional information, refer to “Copying from Non-Volatile Memory to Floppy Disk” on page 2–56.

SINGLE/Copy from Disk to RAM. This button has two functions:

- Each time you press the SINGLE button, the step generator generates one set of step signals and the measurement is performed once. In high-voltage mode, the collector supply provides continuous output, but when in high-current mode it provides one set of pulses, depending on the number of steps selected for the step generator.
- When you hold down the cursor SHIFT button and then press the SINGLE button, the function of this button changes to COPY from disk to non-volatile memory. (Note that this function name is not silkscreened below the button.) The copy function can be used to simultaneously copy up to 16 characteristic curves and 16 front-panel setups from floppy disk to non-volatile memory. For additional information, refer to “Copying from Floppy Disk to Non-Volatile Memory” on page 2–55.

SWEEP. When you press the SWEEP button, the collector supply (or step generator) output automatically sweeps from zero (or 0 A/V) to the value set by the collector supply VARIABLE control (or step generator amplitude + offset).

Sweep mode is available when the collector supply is in high-current mode and when store mode is selected.

When sweeping in the collector supply mode, the measurement is performed as step signals are generated repeatedly over the sweep range.

When sweeping in the step generator mode, the output is limited to 10 times the STEP AMPLITUDE setting; except for the 5 V or 2 A settings. In this exception, the output is limited to five times the STEP AMPLITUDE setting. When the sweep is complete, the output of the step generator returns to the starting offset value. The number of steps remains at 0.

Display Controls

Display controls shown in Figure 2–3 are used to select display modes and to control the vertical and horizontal sensitivity of the characteristic curve display area.

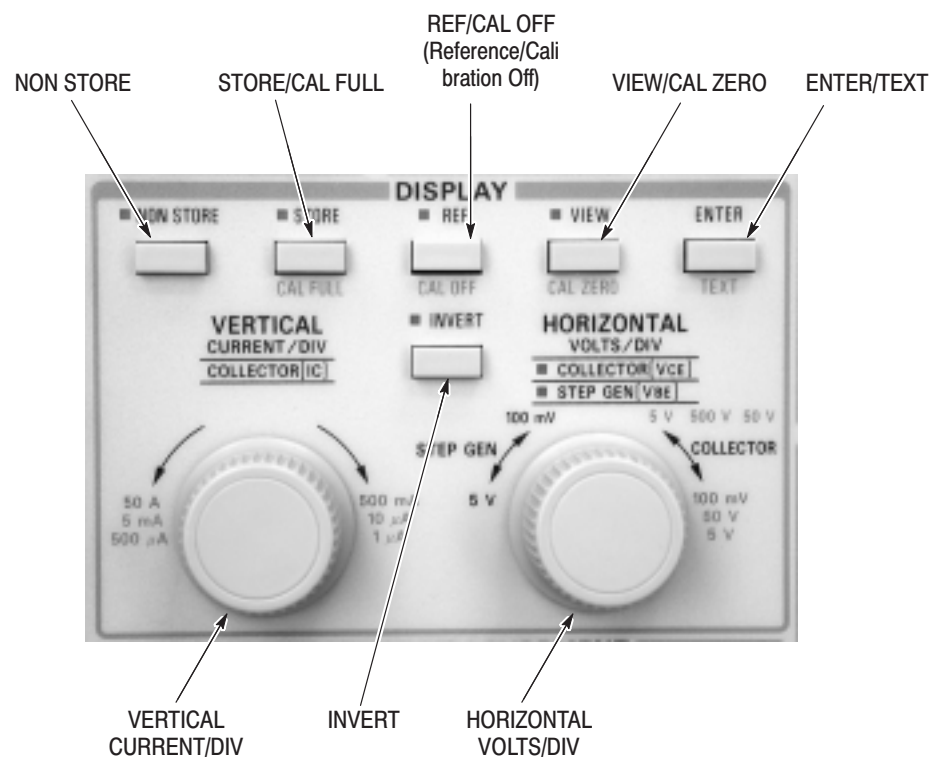

Figure 2–3: Display Controls

NON STORE. Press the NON STORE button to provide a real-time analog display of the device characteristic curve.

STORE/CAL FULL. This button has two functions:

- Press the STORE button to display a digitized characteristic curve of the DUT. The characteristic curve is calculated, digitized, and then converted to analog signals for display on the CRT.
- Hold down the cursor SHIFT button and press the STORE button to change the function to CAL FULL (calibration full) which displays a dot in the top right corner of the screen. This function provides a reference for checking the CRT deflection at the 10th graticule lines (vertical and horizontal).

While in the calibration mode, CAL is displayed in the top right corner of the display.

REF/CAL OFF (Reference/Calibration Off). This button has two functions:

- Press the REF button to save the currently displayed store or view curve in the reference waveform memory and to display the entered curve as a reference curve. Either the store or view curve can be displayed together with the reference curve. The reference curve remains on the CRT until either the REF button is pressed again or non store display mode is selected.

If you press the SAVE button when the reference curve is displayed, the reference curve is saved along with front-panel settings in the selected setup memory location.

- Hold down the cursor SHIFT button and press the CAL OFF button to cancel the calibration full or calibration zero function.

VIEW/CAL ZERO. This button has two functions:

- Press the VIEW button to read a characteristic curve from a selected memory location and to display the curve on the CRT. The memory location number is briefly displayed in the bottom right of the CRT.

NOTE. *If any control setting (except REF) is changed while in view mode, the display mode automatically changes to store mode in order to reflect the results of the changed setting.*

- Hold down the cursor SHIFT button and press the VIEW button to change the function to CAL ZERO, which displays a dot in the bottom left corner of the screen. This function provides a reference for checking the CRT deflection at the “zero point” of the vertical and horizontal graticule lines.

While in the calibration mode, CAL is displayed in the top right corner of the display.

ENTER/TEXT. This button has two functions:

- Press the ENTER button to store the currently displayed store or view curves in mass storage at the selected memory location. (The enter function is not used with the non store display mode.)
- Hold down the cursor SHIFT button and press the ENTER button to activate text edit mode. Text edit mode enables you to enter up to 24 alphanumeric characters and symbols to help identify or label characteristic curves and setup displays.

Press the ENTER button to exit text entry mode.

Refer to “Text Edit Mode” on page 2–48 for additional details on using this mode. Also, refer to “Exercising Text Editing Feature” on page 3–11 for an exercise that demonstrates text entry.

INVERT. This button has two functions:

- Press the INVERT button to invert the non store or store curve on the horizontal and vertical axes. The INVERT LED illuminates. The invert function does not affect either the view or reference curves.
- Hold down the cursor SHIFT button and press the INVERT button to activate the “erase non-volatile memory contents” feature. Note that this secondary function is not printed below the button. Refer to “Erasing Non-Volatile Memory” on page 2–57 for additional information.

VERTICAL CURRENT/DIV. This control sets the sensitivity of the vertical axis. The sensitivity per division of the vertical axis is displayed in the VERT/DIV readout area on the display screen. The sensitivity selection range depends on the collector supply peak power watts setting as listed in Table 2–1.

Table 2–1: Vertical Axis Sensitivity Settings

Peak Power Watts	CURRENT/DIV Range
3 kW	1 A/div to 50 A/div
300 W	500 mA/div to 5 A/div
30 W	100 μ A/div to 5 mA/div
3 W	10 μ A/div to 500 μ A/div
300 mW	10 μ A/div to 500 μ A/div
300 mW	1 μ A/div to 50 μ A/div

Table 2–2 shows the VERT/DIV (vertical per division) selections controlled by the VERTICAL CURRENT/DIV (vertical current per division) control, for specific collector supply settings.

HORIZONTAL VOLTS/DIV. This is a dual purpose control. It selects the source (collector or step generator) and adjusts the sensitivity (volts/division) for the horizontal axis. The sensitivity of the horizontal axis is displayed in the HORIZ/DIV (horizontal per division) readout area on the display screen.

Table 2–2 shows selections controlled by the HORIZONTAL VOLTS/DIV control for specific collector supply settings.

To select the collector supply as the source, rotate the knob clockwise until the COLLECTOR (V_{CE}) indicator located above the control lights. You can then position the control accordingly to select collector (V_{CE}) settings as listed in Table 2-2.

To select the step generator as the source, rotate the HORIZONTAL VOLTS/DIV control counterclockwise until the STEP GEN (V_{BE}) indicator located above the control lights. You can then position the control accordingly to select the step generator (V_{BE}) settings as listed in Table 2-2.

Table 2-2: Display Sensitivity Selections

Collector Supply				VERTICAL CURRENT/DIV Selections	HORIZ VOLTS/DIV Selections	
High Current		High Voltage			STEPGEN (V_{BE})	COLLECTOR (V_{CE})
3 kW	300 W	30 W	3 W			
X				50 A 20 A 10 A 5 A 2 A 1 A	5 V 2 V 1 V 500 mV 200 mV 100 mV	5 V 2 V 1 V 500 mV 200 mV 100 mV
	X			5 A 2 A 2 A 500 mA	5 V 2 V 1 V 500 mV 200 mV 100 mV	5 V 2 V 1 V 500 mV 200 mV 100 mV
		X		5 mA 2 mA 1 mA 500 μ A 200 μ A 100 μ A	5 V 2 V 1 V 500 mV 200 mV 100 mV	500 V 200 V 100 V 50 V
			X	500 μ A 200 μ A 100 μ A 50 μ A 20 μ A 10 μ A	5 V 2 V 1 V 500 mV 200 mV 100 mV	500 V 200 V 100 V 50 V

Cursor Controls

The cursor controls, shown in Figure 2–4, are used to select and position the dot, f line, and window cursors.

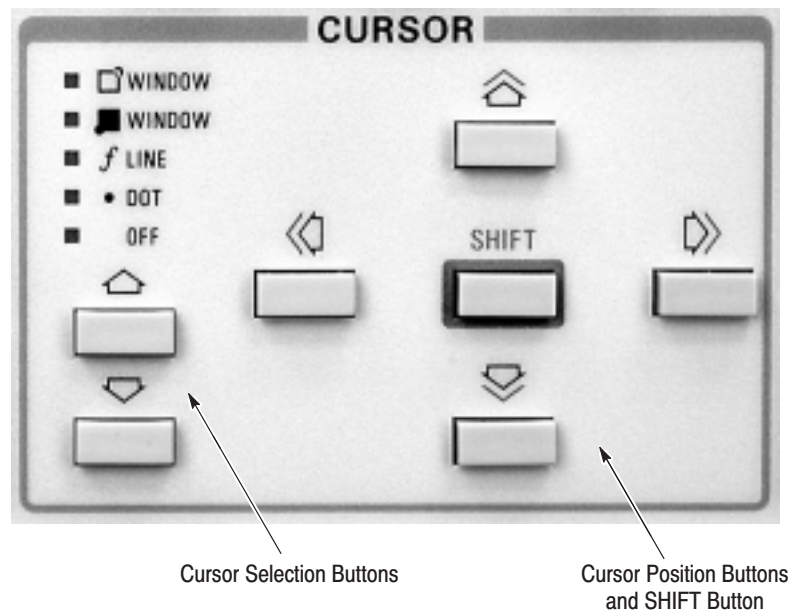

Figure 2–4: Cursor Controls

Cursor Selection Buttons. The cursor select up or down buttons are used to select the dot, f line, or window cursors.

- The dot cursor is a high-intensity dot displayed on the characteristic curve trace. Voltage and current at the cursor position are indicated in the CURSOR readout area. This cursor is also used to measure β (beta).

The dot cursor is positioned using the four cursor position buttons. If the dot cursor is positioned off screen, the corresponding part (vertical or horizontal) of the CURSOR readout blinks.

When a reference curve is displayed, the dot cursor is displayed only on the store or view curve. The dot cursor is not displayed in the non store display mode.

- The f line (function line) cursor is used to measure either the “on” resistance or the horizontal intercept voltage of a DUT. The f line cursor is a straight line that passes through the dot cursor position at a slope that can be changed by the four cursor position buttons. The slope is indicated in the CURSOR (f:1/grad) readout area of the CRT.

The point at which the f line cursor intercepts the horizontal axis is indicated in the CURSOR (f: 1/intercept) readout area, which indicates the horizontal coordinate value.

If the reference curve is displayed, the f line cursor appears only on the store or view curve. The f line cursor is not displayed in non store mode

- A rectangular window cursor can be used in any display mode as a reference for visual checks. It can also be used to measure small signal β (beta).

You can select one of two window cursors; one with a bright dot in its bottom left corner, the other with a bright dot in its top right corner. Cursor movement and the cursor readout display are referenced to the bright dot.

Refer to “Using Display Cursors” on page 2–47 for additional information. Also, refer to “Measurement Exercises” on page 3–17 for exercises that demonstrate the use of the dot, f line, and window cursors.

Cursor Position Buttons and SHIFT Button. The four cursor position buttons (up down left right) are used to either move the dot and window cursors, or to change the slope of the f line cursor. Holding down the cursor SHIFT button and pressing any of the cursor position buttons makes the cursor move faster.

The cursor SHIFT button is also used to change the function of other controls on the front panel. The alternate function is printed in blue below each button. Table 2–3 shows the alternate functions that can be selected by the cursor SHIFT button.

Table 2-3: Alternate Functions Controlled by the SHIFT Button

Button	Alternate Effect
SAVE	Changes the button function to FORMAT, to initiate floppy disk formatting.
RECALL	Changes the button function to DIRECTORY, which displays a directory of the contents of the mass storage on the CRT.
STORE	Changes the button function to CAL FULL, which displays a dot to check the deflection accuracy of the CRT.
REF	Changes the button function to CAL OFF, which turns off the cal full or cal zero display.
VIEW	Changes the button function to CAL ZERO, which displays a dot to check the deflection accuracy of the CRT.
ENTER	Changes the button function to TEXT, which places the 371B in text edit mode for text entry and revision.
REPEAT	Changes the button function to COPY, which copies the contents of non-volatile memory to floppy disk. This alternate function is not printed below the button.
SINGLE	Changes the button function to COPY, which copies the contents of the floppy disk to RAM. This alternate function is not printed below the button.
Cursor Position (up, down, left, right)	Increase the rate of cursor movement.
RESET TO LOCAL	Changes the button function to ADDR, which reads in the settings of the rear-panel configuration switch bank and displays them on the CRT.
USER REQUEST	Changes the button function to ID, which displays the firmware version of the 371B on the CRT.
HARDCOPY	Changes the button function to BMP FILE, which converts the CRT image to monochrome BMP file format and save it into the floppy disk.
OFFSET (up down)	Increases the rate of offset increase or decrease.
STEP MULTI	Changes the button function to DISABLE, which disables the step generator output.

Step Generator Controls

The step generator controls are shown in Figure 2–5.

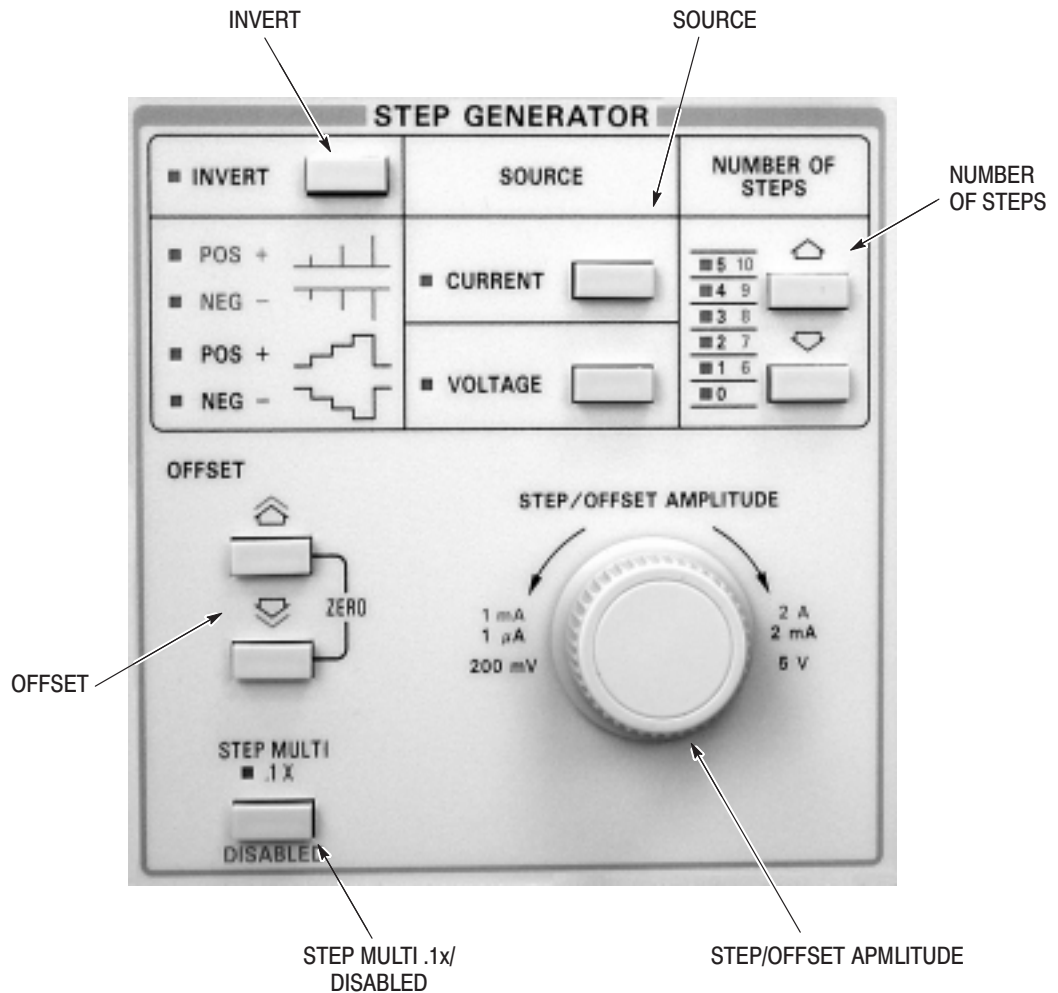

Figure 2–5: Step Generator controls

INVERT. Press the polarity INVERT button to invert the polarity of the step generator. The step generator polarity is automatically changed when the collector supply polarity is changed. Therefore, when necessary, the INVERT button is used to reverse polarity changes caused by changing the collector supply polarity.

The INVERT indicator, located beside the button is lit to indicate inverted polarity.

SOURCE. Press either the CURRENT button or VOLTAGE button to set the step generator output to either a current step signal or a voltage step signal. The selected source is indicated by the corresponding LED.

NUMBER OF STEPS. Use the NUMBER OF STEPS up or down buttons to select the number of steps produced by the step generator.

The range of steps is selectable from 0 to 10 except when the step amplitude is set to either 5 V or 2 A. In the latter case, the maximum offset is limited to five times the step amplitude. If the offset is over five times and the step amplitude is changed to either 5 V or 2 A, the offset will be changed automatically to the maximum allowable in those settings, five times.

NOTE. *When 0 steps are selected, the step generator output consists of offset only. Refer to the description of the OFFSET button immediately following for additional information.*

Simultaneously press the up and down buttons to set the number of steps to 2. The NUMBER of STEPS LEDs are green for steps 0 to 5; orange for steps 6 to 10.

OFFSET. The up and down OFFSET buttons allow you to add an offset level to the step signal. The offset has the same polarity as the step signal.

The range of step offset is from 0 to 10 times the step amplitude for most step amplitude settings. When the step amplitude is set to either 5 V or 2 A, the maximum offset is reduced to five times the step amplitude. If the offset is over five times and the step amplitude is changed to either 5 V or 2 A, the offset will be changed automatically to the maximum allowable in those settings, five times.

When the step signal is a pulse signal, the offset level is added as a pulse. The selected amount of offset is displayed in the OFFSET readout area of the CRT.

Hold down the cursor SHIFT button and press either of the OFFSET buttons to cause offset changes in larger increments.

Simultaneously press the OFFSET up and down buttons to set the offset to zero.

STEP MULTI .1X/DISABLED. This is a dual function button that provides the following functions.

- Press the STEP MULT .1X button to reduce the step signal amplitude by a factor of 10 without affecting the offset amplitude. The indicator above the button lights when the step multi function is enabled.

- Hold down the cursor **SHIFT** button and press the **STEP MULTI .1X** button to change the button function to **DISABLED**. This action disables the output and readout display functions of the step generator.

STEP/OFFSET AMPLITUDE. Rotate the **STEP/OFFSET** control to set the amplitude of the generated steps and the range of the offset.

The step amplitude is selected in a sequence of steps in the following ranges:

Current Steps:	
When the collector supply is in high-voltage mode	Step waveform, 1 μ A/step to 2 mA/step
When the collector supply is in high-current mode	Pulse waveform, 1 mA/step to 2 A/step
Voltage Steps:	Step waveform, 200 mV/step to 5 V/step

Offset amplitude is set by using the **STEP/OFFSET AMPLITUDE** control together with the **OFFSET** buttons.

Collector Supply Controls

The collector supply controls are shown in Figure 2-6.

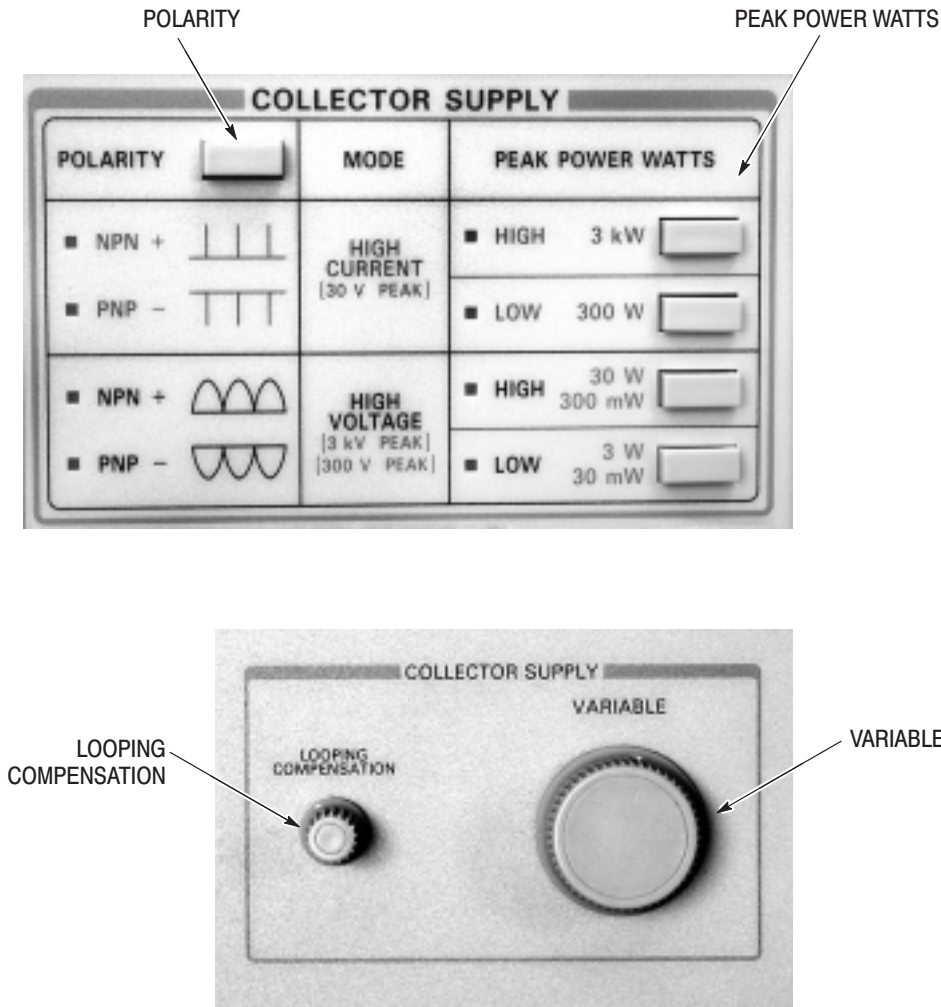

Figure 2-6: Collector Supply controls

POLARITY. Press this button to select the polarity of the collector supply and to simultaneously switch the polarity of the step generator.

Each polarity setting (NPN+ and PNP- for high voltage and NPN+ and PNP- for high current) has an indicator which is lighted when that setting is selected.

The collector supply output automatically goes to 0 % when the polarity is switched. The step generator output level remains unchanged (except for the reversed polarity).

PEAK POWER WATTS. The peak power watts buttons select the maximum power output of the collector supply. The six peak power watt selections, 30 mW, 300 mW, 3 W, 30 W, 300 W, and 3 kW, are split between two collector supply modes: high current and high voltage.

To select the 30 mW or 300 W range, hold down the cursor SHIFT button and then press the 3 W or 30 W peak power watts button. The red LED lights if the 30 W or 3 W setting is selected, and the green LED lights if the 3 kW, 300 W, 300 mW, or 30 mW setting is selected.

Press the 3 kW or 300 W button to place the collector supply in high-current mode, where the output consists of 250 μ s pulses and the peak voltage available is 30 V.

Press either the 30 W or 3 W button to place the collector supply in high-voltage mode, where the output is a full-wave rectified sine wave and the maximum voltage available is 3 kV. When either 30 W or 3 W is selected, the PEAK POWER WATTS LED lights green.

The collector supply output automatically goes to 0 % when the maximum voltage setting is changed.

LOOPING COMPENSATION. Use the LOOPING COMPENSATION control to compensate for stray capacitance that may occur in the 371B and test fixture unit when the collector supply is in high-voltage mode.

VARIABLE. Rotate the collector supply VARIABLE knob to vary the collector supply voltage output. The output voltage is indicated in the % of COLLECTOR PEAK VOLTS readout area as a percent of the peak voltage available.

GPIB Controls and Floppy Disk Drive

The GPIB controls and floppy disk drive are shown in Figure 2-7.

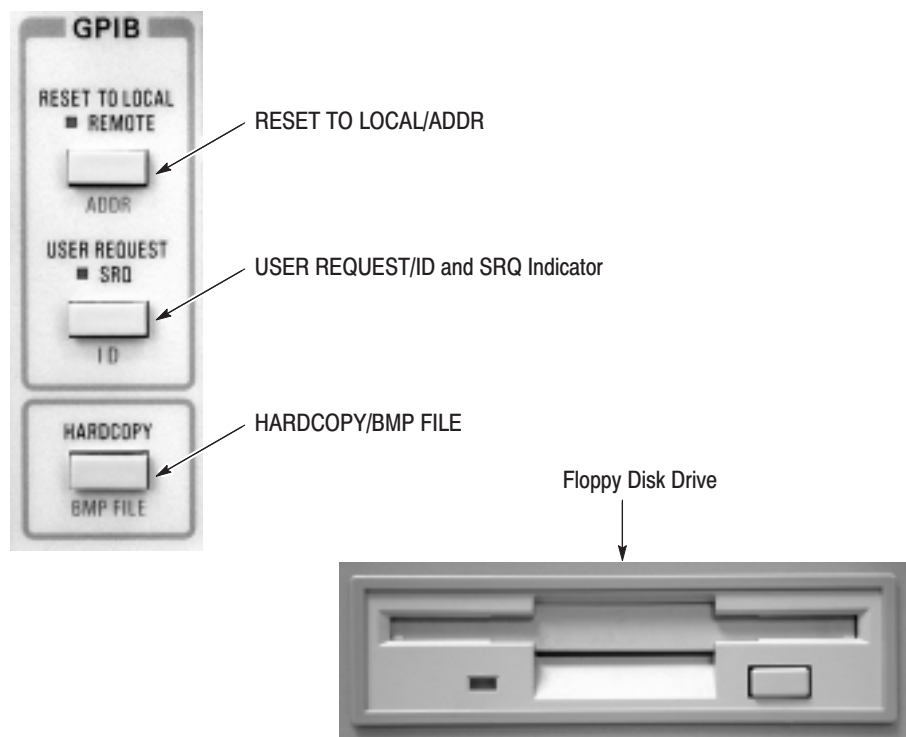

Figure 2-7: GPIB controls and Floppy Disk Drive

RESET TO LOCAL /ADDR. The RESET TO LOCAL/ADDR button has two functions:

When the 371B is controlled by the GPIB, the REMOTE indicator lights. Press the RESET TO LOCAL button to switch the 371B back to local (front panel) control.

- When the remote enable (REN) signal has been sent over the GPIB and my listen address (MLA) is received, the 371B goes into remote mode and the REMOTE indicator is lit. In remote mode, the 371B executes interface messages and device-dependent messages received via the GPIB.
- Hold down the cursor SHIFT button and press the RESET TO LOCAL button to change the button function to ADDR. This causes the 371B to read the GPIB address and message terminator selections on the rear-panel TERMINATION and ADDRESS SELECT switches. Once received by the 371B internal processor, the selections are displayed on the CRT.

USER REQUEST/ID and SRQ Indicator. This button has two functions:

- Press the USER REQUEST button to make the 371B send a service request (SRQ) signal over the GPIB.

The SRQ indicator, located above the USER REQUEST button, lights to indicate that a service request is being sent. The SRQ indicator goes off when a serial poll is executed and the controller acknowledges the service request.

- Hold down the cursor SHIFT button and press the USER REQUEST button to change the button function to ID. This action displays the 371B firmware version number on the display screen.

HARDCOPY/BMP FILE. This button converts the CRT image, cursors, text, graticule and setup data into BMP file format and outputs to the printer connected to the PRINTER PORT on the rear panel of the 371B. Use the Centronics cable with 25-pins DSUB connector to connect the printer. The supported printer is CBM: model iDP3240. Refer to the web site, <http://www.jcbm.co.jp/> for more printer information.

Pressing the HARDCOPY button while holding down the cursor SHIFT button causes the 371B to convert the CRT image to monochrome BMP file format and save it into the floppy disk.

Pressing the HARDCOPY button while holding down the LOCAL ADDR button causes the 371B to convert the waveform to CSV file format and save it into the floppy disk.

Floppy Disk Drive. The 371B can write/read 2HD floppy disk and can read 2DD floppy disk. Up to 64 families of curves can be stored or recalled by the ENTER or VIEW button. Up to 64 setups can be stored or recalled by pressing the SAVE or RECALL button. Press eject button to remove diskette. The LED indicator indicates if the disk drive is active. When the red light is on, the drive is either reading from or writing to the disk. When the light is off, the drive is not operating.



CAUTION. Do not press the eject button while the LED indicator is on. The disk drive or the floppy disk can be damaged.

Signal Output Controls, Indicators and Connectors

Signal output controls, indicators, and connectors are shown in Figure 2–8.

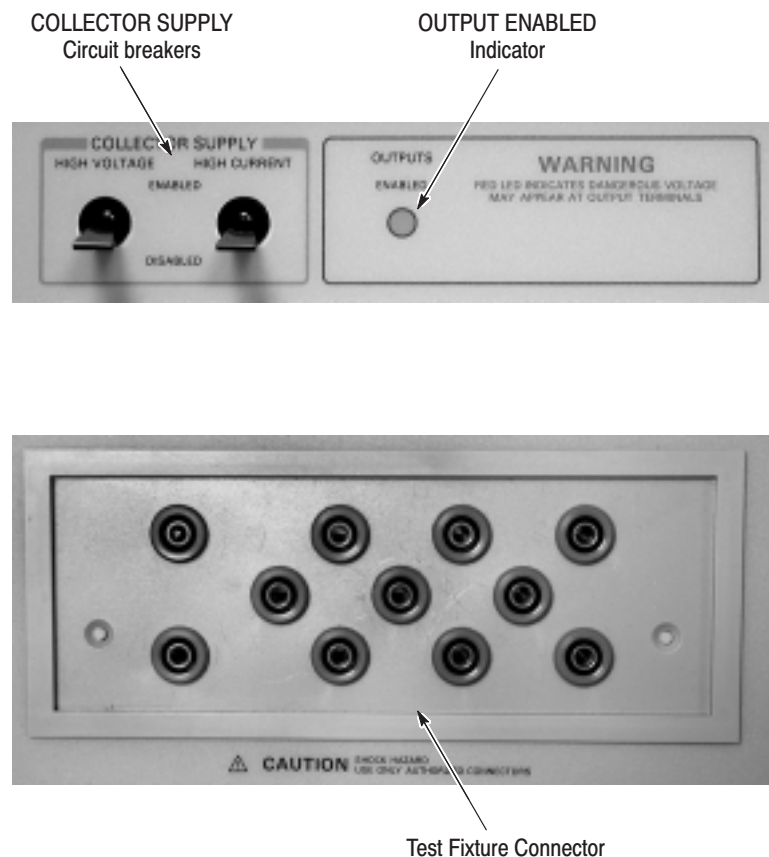

Figure 2–8: Signal output controls, indicators, and connectors

COLLECTOR SUPPLY Circuit breakers. The HIGH VOLTAGE and HIGH CURRENT circuit breakers enable or disable the collector supply output. If the 371B detects an overcurrent condition, it automatically trips the breakers to disable output.

OUTPUT ENABLED Indicator. The OUTPUTS ENABLED indicator lights when the collector supply or step generator outputs are enabled.

This indicator turns off when one of the following occurs:

- The test fixture unit is not connected
- The test fixture unit protective cover is open

- The collector supply peak power is exceeded
- The output is disabled for any other reason

When the OUTPUTS ENABLED indicator is off, both the output and sense connectors are open circuits.

Test Fixture Connector. The test fixture connector provides interconnection between the test fixture unit and the 371B.

Rear Panel

The rear panel is shown in Figure 2-9.

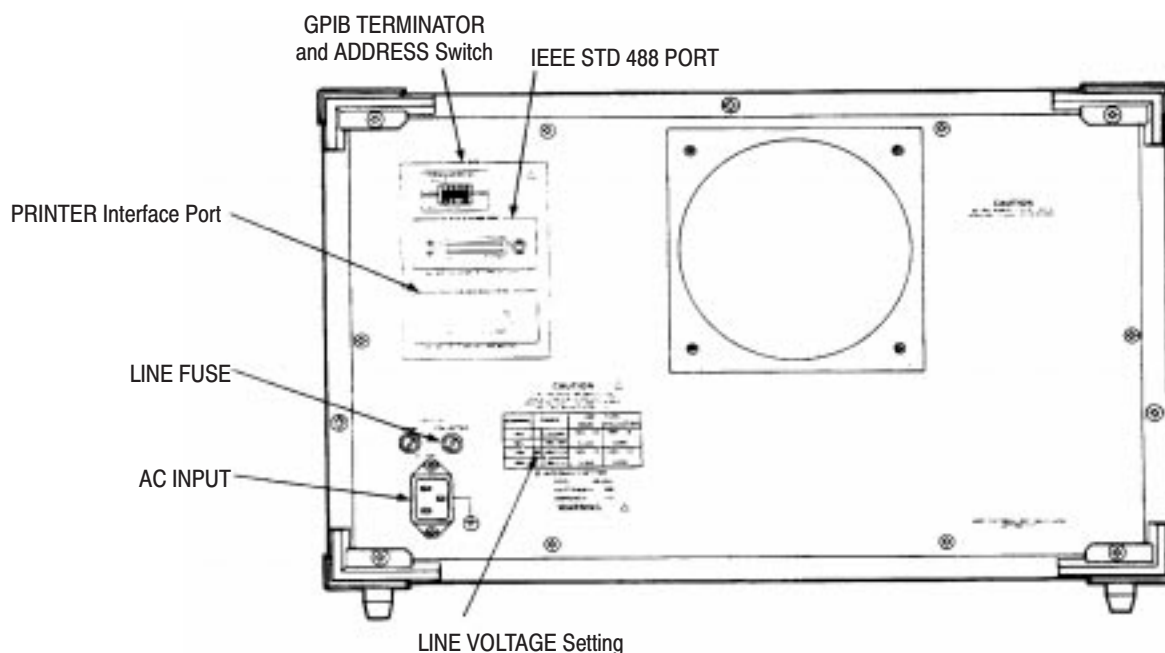

Figure 2-9: Rear panel controls and connectors

GPIB TERMINATOR and ADDRESS Switch. The GPIB TERM (termination) switch and the ADDRESS switch selects the message terminator and sets the 371B GPIB address. Refer to “Choosing the Message Terminator” on page 4-12 for additional information.

The left-most switch (as viewed when facing the rear panel) sets the message terminator; the other five switches set the address of the 371B on the GPIB. New settings become effective when the RESET TO LOCAL/ADDR button (on the front panel) is pressed while holding down the cursor SHIFT button. Refer to “Setting the Bus Address” on page 4-11 for additional information.

IEEE STD 488 PORT. This is the GPIB connector.

PRINTER Interface Port. This is the printer interface port.

LINE FUSE. The MAIN fuse receptacle contains the power line fuse. The COLLECTOR fuse receptacle contains the collector supply fuse.

AC INPUT. This connector is for the AC power cord.

LINE VOLTAGE Setting. The line setting of the 371B is indicated by a screw in this area on the rear panel.

Test Fixture Unit and Panel Connectors

The following describes the signal lines at the connectors on the patch and adapter panels of the test fixture unit. These connectors are shown in Figure 2–10.

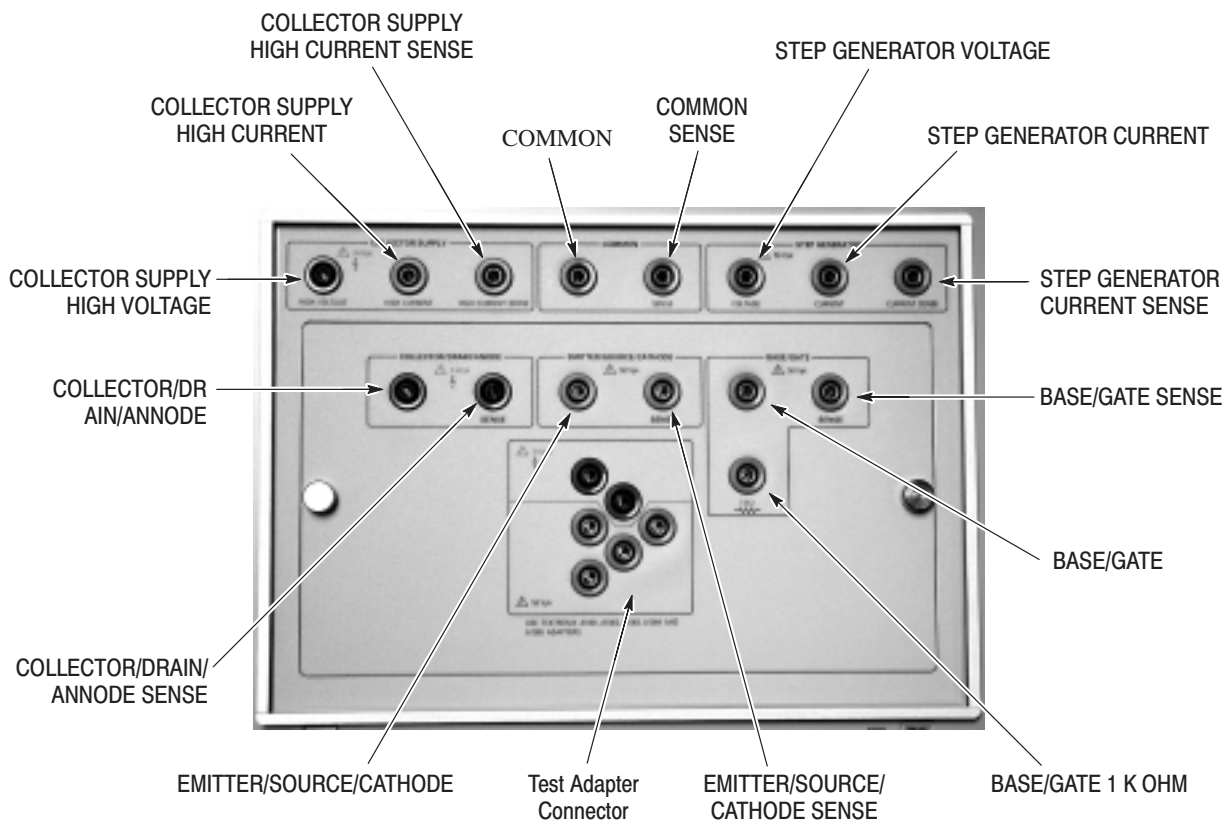

Figure 2–10: Test fixture unit connectors

COLLECTOR SUPPLY HIGH VOLTAGE. The COLLECTOR SUPPLY HIGH VOLTAGE connector is the collector supply output in high-voltage mode (when the peak power watts setting is 30 mW, 300 mW, 3 W, or 30 W).

A rectified sine wave with a maximum amplitude of 300 V (30 mW or 300 mW) or 3 kV (3 W or 30 W) is available at this connector.

COLLECTOR SUPPLY HIGH CURRENT. The COLLECTOR SUPPLY HIGH CURRENT connector is the collector supply output in high current mode (when the peak power watts setting is 300 W or 3 kW).

A voltage pulse with a maximum amplitude of 30 V and a pulse width of 250 μ s is available at this connector.

COLLECTOR SUPPLY HIGH CURRENT SENSE. The COLLECTOR SUPPLY HIGH CURRENT SENSE connector is the collector voltage sense connector in high current mode (when the peak power watts setting is 300 W or 3 kW).

COMMON. The COMMON connector is the signal common for the collector supply and the step generator outputs.

COMMON SENSE. The COMMON SENSE connector is used as the common sense voltage line.

STEP GENERATOR VOLTAGE. The STEP GENERATOR VOLTAGE connector is the output for the step generator signal in voltage source mode.

STEP GENERATOR CURRENT. The STEP GENERATOR CURRENT connector is the output for the step generator signal in current source mode.

The output can be either a pulse with a maximum amplitude of 10 A, offset of 10 A, and a width of 500 μ s, or a staircase signal with a maximum amplitude of 20 mA and offset of 20 mA. Which output is available depends on whether you are operating the collector supply in high-voltage or high-current mode.

STEP GENERATOR CURRENT SENSE. The STEP GENERATOR CURRENT SENSE connector is the sense input for base voltage (V_{BE}) measurements in current source mode.

COLLECTOR/DRAIN/ANODE. The COLLECTOR/DRAIN/ANODE connector is connected inside the adapter panel to the collector terminal of the test adapter connector.

COLLECTOR/DRAIN/ANODE SENSE. The COLLECTOR/DRAIN/ANODE SENSE connector is connected inside the adapter panel to the collector sense terminal of the test adapter connector.

EMITTER/SOURCE/CATHODE. The EMITTER/SOURCE/CATHODE connector is connected inside the adapter panel to the emitter (or equivalent) terminal of the test adapter connector.

EMITTER/SOURCE/CATHODE SENSE. The EMITTER/SOURCE/CATHODE SENSE connector is connected inside the adapter panel to the emitter sense terminal of the test adapter connector.

BASE/GATE 1 K OHM. The BASE/GATE 1 K OHM connector is connected inside the adapter panel through a 1 k Ω resistor to the base terminal of the test adapter connector.

BASE/GATE. The BASE/GATE connector is connected inside the adapter panel to the base terminal of the test adapter connector.

BASE/GATE SENSE. The BASE/GATE SENSE connector is connected inside the adapter panel to the base sense terminal of the test adapter connector.

Test Adapter Connector. A test adapter plugs into the test adapter connector. These connections are wired inside the adapter panel to connectors 55 – 61.

Readout Display

The readout display shown Figure 2–11 consists of a graticule area and an area that displays various setups and measurement information. Display information consists of the following:

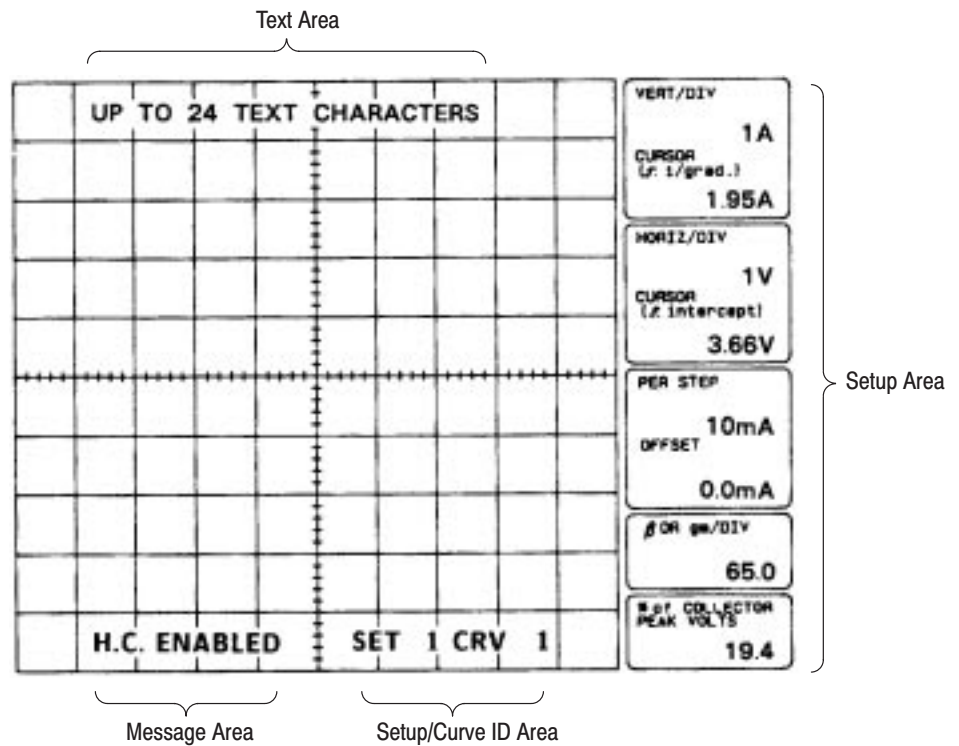

Figure 2–11: Display Screen

Setup Area. The setup display area provides readouts for VERT/DIV, HORIZ/DIV, PER STEP, OFFSET, β or gm/DIV, % of COLLECTOR PEAK VOLTS, and cursor measurement readouts for vertical and horizontal axes.

When the reference curve is displayed, readout data of the store or view curve are displayed in these readout areas; not the readout data for the reference curve. Refer to “Reference (REF) Display Mode” on page 2–46 for additional information.

Text Area. The location that displays up to 24 characters of user selectable text.

Message Area. System messages (such as OPERATION ERR, SAVE COMPLETE, CHECKSUM ERROR, ERASE COMPLETE, etc.) are displayed in this area for about five seconds and are then automatically erased.

Setup/Curve ID Area. The memory location of the curve currently displayed is identified by pressing the VIEW button. This memory index number is called the curve ID (identification).

The memory location of setup information for the currently displayed curve is identified on the display by pressing the RECALL button. This memory index number is called the setup ID.

The curve ID and setup ID are removed from the display when a front-panel setting is changed or after five seconds have elapsed.

Operating Basics

This chapter describes general operating basics of the 371B.

The following information leads you through the major operations associated with device measurements in the sequence listed below.

- Device connection
- Test fixture interlock
- Device stimulus
- Data acquisition
- Measurement modes
- Device characteristics display
- Display modes
- Display cursors
- Text editing
- Memory and mass storage
- Disk formatting
- Floppy disk handling
- 371B interfaces

Device Connection

The DUT connects to the 371B via the test fixture unit. All tests are made with the device mounted inside the test fixture unit and its protective cover closed. You can connect the DUT using one of two methods:

- With the adapter panel and a selected test adapter
- With patch cords and alligator clips

Connecting a DUT using the adapter panel and a test adapter

The adapter panel is mounted inside the test fixture unit and is used with test adapters and patch cords to connect semiconductors with common lead configurations to the 371B. Figure 2–12 shows the connecting links between the DUT and the 371B when using the adapter panel and test adapters.

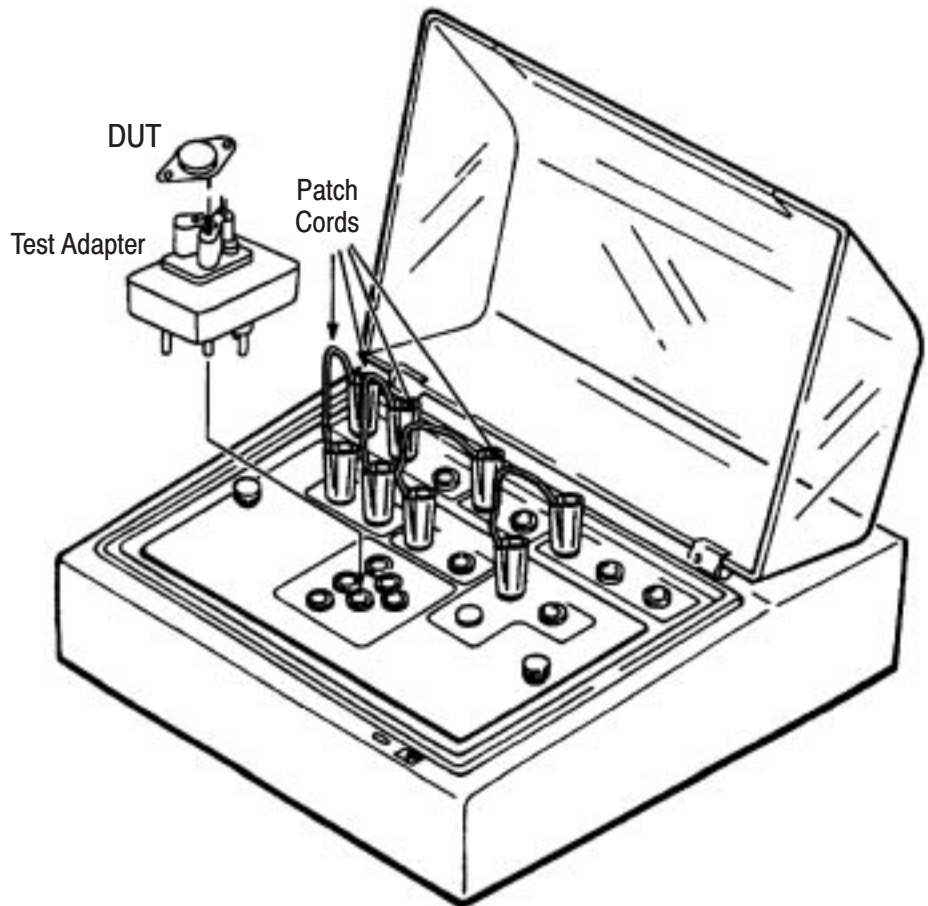

Figure 2–12: DUT connection path when using adapter panel and test adapters

NOTE. When making high-voltage measurements, do not make connection between the COLLECTOR SUPPLY HIGH CURRENT SENSE connector and the COLLECTOR/DRAIN/ANODE SENSE connector, or between the COMMON SENSE connector and the EMITTER/SOURCE/CATHODE SENSE connector. Resulting voltage and current measurements may be incorrect.

Test Adapters. Two test adapters are provided as standard accessories for the 371B: the A1002 (In-Line Lead) and the A1003 (TO-3/TO-66). Two other test adapters are available as optional accessories: the A1001 (Blank Adapter) and the A1005 (Axial Lead).

The test adapters have voltage ratings that must not be exceeded. These voltage ratings are shown in Table 2–4.

Table 2–4: Test Adapter Voltage Ratings

Type	Case Type	Voltage Rating
A1001	Blank	
A1002	In-Line Lead Adapter	1000 V
A1003	TO-3/TO-66 Adapter	2000 V
A1005	Axial Lead Adapter	2000 V



CAUTION. Do not apply voltages that exceed the voltage ratings listed in Table 2–4. Further, the adapters are plastic and can be damaged by excessive heat resulting from repetitive testing. When a test is expected to generate excessive heat, obtain a single measurement and store the pulse for display using store mode.

Figure 2–13 illustrates the pin configuration for the various test adapters.

Figure 2–14 shows the internal wiring of the adapter panel. This illustration helps to visualize signal routing from the adapter plug connections to the patch panel connections.

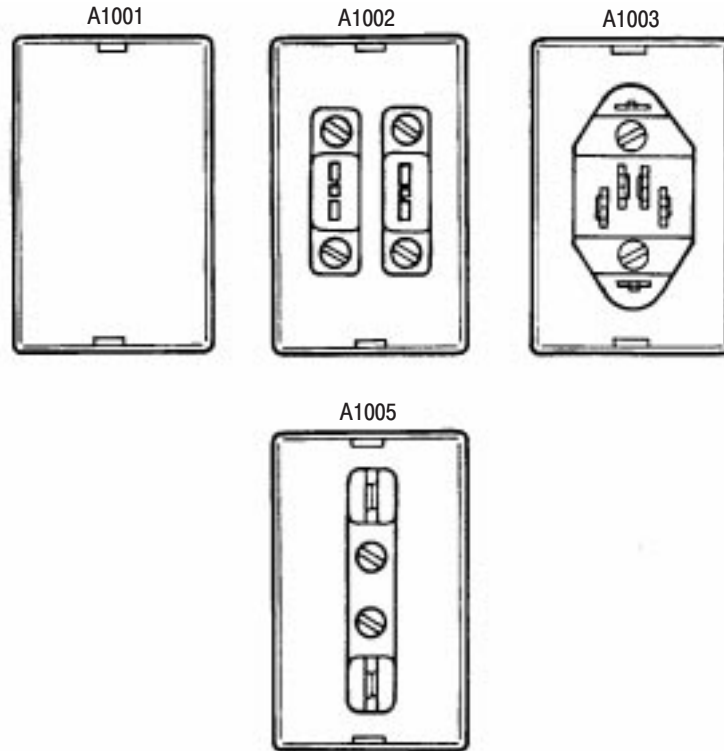

Figure 2-13: Test adapter pin configuration

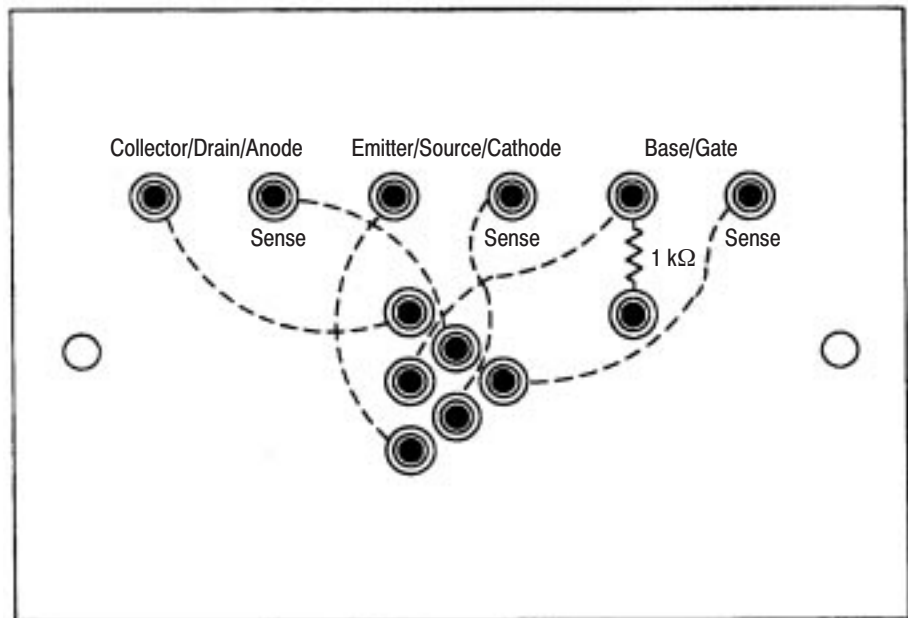

Figure 2-14: Internal wiring (signal path) of adapter panel

Connecting a DUT Using Patch Cords

Many semiconductor devices do not have standard lead configurations or may be too large to fit into a test adapter. Patch cords with alligator clips can be used to connect a DUT directly to the test fixture unit, as described in the following paragraph.

If the physical shape or operating voltage of the DUT prevents use of a test adapter, you can easily remove the adapter panel by loosening two thumb screws and lifting the adapter panel out of the test fixture unit as shown in Figure 2–15. Now you can connect the device directly to the patch panel as shown in Figure 2–15.

Test Fixture Interlock

The 371B main unit/test fixture is provided with a safety interlock system that disables the collector supply voltage whenever the test fixture cover is in the raised position. Whenever the collector supply voltage is disabled you can safely connect and disconnect devices at the patch panel.

When the cover is closed, the collector supply voltage is enabled. The enabled state is indicated by a red WARNING indicator. When lit, the WARNING indicator indicates that the collector supply is enabled and that a dangerous voltage may appear at the patch panel terminals on the test fixture unit.



WARNING. *Do not disable the safety interlock and then attempt to operate the 371B. You may accidentally contact high voltage and serious personal injury or death may result.*

The collector supply is also disabled whenever the test fixture unit cable is disconnected from its connector at the front panel of the main unit.

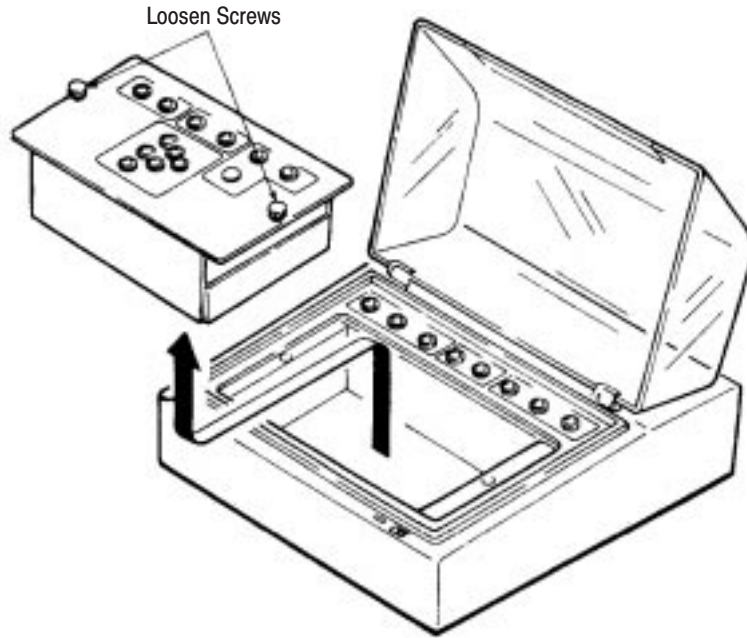
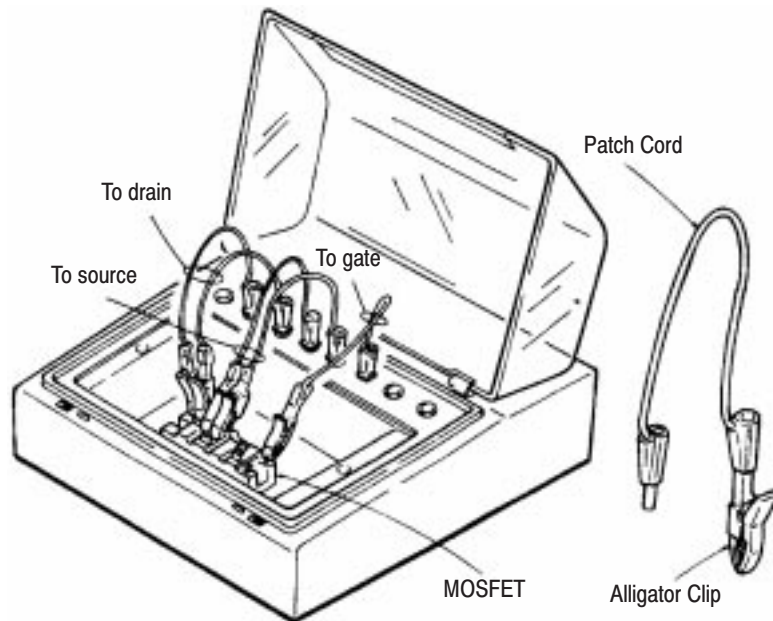

Figure 2-15: Removing the adapter panel



In this example, connections are for measuring the common-source characteristics of an FET.

Figure 2-16: Connecting a device directly to the test fixture unit using patch cords

Device Stimulus

Operating stimuli (voltage and current) are provided by the collector supply and step generator circuits. The outputs from the collector supply and the step generator circuits are applied to the DUT to begin the process of producing characteristic curves, displays, and related readout information.

NOTE. *When either the test fixture unit is disconnected from the main unit, or its protective cover is open (when connected to the main unit), the collector supply and step generator outputs are disabled to prevent dangerous voltages and currents at exposed connectors. The main unit also shuts down the collector supply and step generator outputs in the event overheating is detected in the output circuits.*

The Collector Supply

The collector supply provides a wide range of operating voltages at various power settings for the DUT. Voltage and power selection are controlled by the collector supply controls. With these controls you can select to operate in either a high-voltage or a high-current mode (with various selections in each mode), and can select output polarity of the device to be tested, NPN+ or PNP -. In addition, you can vary the output voltage within the range determined by the maximum peak voltage selected by rotating the collector supply VARIABLE knob.

The collector supply high voltage and high current outputs are connected to the test fixture unit and appear at its COLLECTOR SUPPLY HIGH VOLTAGE and COLLECTOR SUPPLY HIGH CURRENT connectors, respectively.

Finally, the collector supply has a LOOPING COMPENSATION control that compensates for looping which sometimes occurs when the measured current is extremely low. A looping condition is evident when the displayed characteristic curve takes the form of a loop. Looping is the result of either the capacitance of the 371B and the test fixture unit, or the capacitance of the DUT.

It is not possible to completely compensate for capacitance in all semiconductor devices. The LOOPING COMPENSATION control simply provides some compensation for floating capacitance in small diodes and in voltage-driven, three-lead devices.

The Step Generator

The step generator circuit provides the current or voltage applied to the base, gate, or emitter of the DUT. You set the desired current and voltage selections using the step generator controls. The output may be either a staircase current or voltage waveform with fixed increments, or a pulse current waveform. You can select voltage or current output with the VOLTAGE or CURRENT source buttons, while the type of waveform produced is determined by both the source setting and the collector supply peak power watts setting. When the source is CURRENT and the peak power watts is set to 3 kW or 300 W, the step generator outputs a pulsed waveform.

If you choose a pulsed waveform you can select from 0 to 10 steps using the number of steps up or down buttons (except when you choose 5 V or 2 A; in which case the number of steps ranges from 0 to 5). You can use the STEP/OFF-SET AMPLITUDE knob to select the step amplitude. The step amplitude setting is displayed on the CRT in the PER STEP readout field.

You can reduce the step amplitude by a factor of 10 by pressing the STEP MULTI .1X button. The step generator provides other features that are described in more detail in the “Operating Exercises” on page 3–2 and in “Measurement Exercises” on page 3–17.

The step generator voltage and step generator current signals are output to the test fixture unit and appear at its STEP GENERATOR VOLTAGE and STEP GENERATOR CURRENT connectors.

Setting Offset. You can add plus (+) or minus (–) DC offset to the step generator output signal by pressing the up or down offset buttons, respectively. The offset is the same polarity as the step generator signal. When the step signal is a staircase waveform, the offset is either a DC voltage or a DC current, depending on whether the step generator is operating in voltage or current mode. When the step signal is a current pulse, the pulse itself is offset. You can select an offset amplitude that is 1 to 10 times the step amplitude. An exception is when you have selected either the 5 V or 2 A step amplitude settings. In this case, the amount of offset is from 0 to 5 times the step amplitude. The selected offset amplitude is indicated on the CRT in the OFFSET readout area.

NOTE. *The offset is independent of the STEP MULTI .1X setting and the measurement mode. The amplitude of the selected offset is always at a constant value.*

Setting Polarity. The polarity of the step generator signal is switched when the polarity of the collector supply is changed. This ensures that when the collector supply POLARITY setting is NPN+, the step generator polarity is POS+, and conversely, when the collector supply POLARITY setting is PNP –, the step generator polarity is NEG –. Some FET measurements may require that you set the polarity of the step generator signal to be opposite the polarity of the collector supply signal. To do this, press the step generator INVERT button.

Data Acquisition

The 371B senses the effect of the collector supply and step generator stimulus signals on the DUT and performs voltage sensing using the SENSE connectors at the patch panel. The SENSE connectors provide a high-impedance path back to the 371B for voltage measurement. The SENSE connections allow the 371B to make precise voltage measurements by making connections close to the DUT, rather than measuring the voltage at the collector or step generator output of the power supply.

The STEP GENERATOR CURRENT SENSE connector on the patch panel is for Kelvin sensing of base voltage (V_{BE}) measurements in high current mode. For Kelvin sensing purposes, this sensing connector is independent of the power supply connector. This improves the accuracy of measurements because it eliminates any voltage drop due to contact resistance.

Voltage can be measured without connecting the device to the STEP GENERATOR CURRENT SENSE connector, but for high precision measurements this sense connector should be used.

Measurement Modes

The collector supply and step generator provide voltage and current output signals for three different measurement modes: repeat, single, and sweep, as selected by the REPEAT, SINGLE, and SWEEP buttons. The particular mode selected depends on the DUT, and the specific characteristics you wish to measure.

Repeat Mode

In repeat mode, the pulse or swept outputs of the collector supply and step generator continuously repeat as selected by the collector supply and step generator controls. The repeat mode is automatically selected when the 371B is powered-up or initialized. This mode is normally used when device overheating is not a concern.

Single Mode In single mode, the step generator outputs a single pulse or a staircase (stepped) waveform each time you press the SINGLE button. In high-current mode, the collector supply provides one pulse per number of steps selected. Thus, if device overheating is a problem, you can use single sweep mode to pulse the DUT once to acquire the desired characteristic. You can store this characteristic in memory, then display it from memory on the CRT.

Sweep Mode In sweep mode, the pulsed collector supply or step generator output amplitude sweeps from 0 V to its preselected value. The result is a continuous curve displayed on the CRT rather than a single measured point.

In sweep mode, the collector and base of the DUT are being pulsed continuously using a low duty cycle. Because of the low duty cycle, this mode allows you to view a complete curve without overheating your device.

There is a version of sweep mode for both the collector supply and the step generator as described in the following:

Collector Supply Sweep Mode. The 371B is in collector supply sweep mode when the controls are set as follows:

Collector Supply

VARIABLE any setting except 0%
 PEAK POWER WATTS 300 W or 3 kW

Display

MODE STORE
 HORIZONTAL VOLTS/DIV . COLLECTOR (V_{CE}) RANGE

If you try to exercise collector sweep mode with the controls in any other position, you will receive an OPERATION ERROR message.

When collector sweep mode is in effect, the collector % is displayed in the HORIZ/DIV readout area. In this mode, the collector supply output sweeps from 0% to the value selected by the collector supply VARIABLE control. When using the dot cursor, collector voltage may also be displayed.

For increased resolution, you can reduce the distance between displayed dots to one quarter their normal distance by holding down the cursor SHIFT button then pressing the SWEEP button. This action decreases the sweep speed by a factor of four.

The step generator outputs continuously in collector supply sweep mode.

Step Generator Sweep Mode. This mode sweeps the step generator output from its offset value to peak value (step amplitude + offset). The 371B is in step generator sweep mode when the controls are set as follows:

Collector Supply

PEAK POWER WATTS 300 W or 3 kW

Display

MODE STORE
HORIZONTAL VOLTS/DIV . STEP GEN (V_{BE}) RANGE

Step Generator

OUTPUT any setting except 0 V (or 0 A)

If you press SWEEP and the 371B controls are set at 0 V or 0 A, the 371B will display the OPERATION ERROR message.

The sweep voltage or current is displayed in the OFFSET readout area of the display (the initial value displayed is the offset value). In sweep mode, the number of steps for the step generator defaults to 0 steps.

NOTE. *The sweep end voltage or current is limited to 10 times the STEP AMPLITUDE setting, except for the 5 V or 2 A setting. If the STEP AMPLITUDE setting is 5 V or 2 A the sweep end voltage or current is limited to five times the STEP AMPLITUDE setting.*

You can reduce the distance between displayed dots to one-half their normal distance by holding down the cursor SHIFT button then pressing the SWEEP button. This action decreases the sweep speed by a factor of two.

The collector supply outputs continuously when in step generator mode.

Defeating Sweep Mode. If you change any front-panel control (except for the controls listed in Table 2–5), the 371B reverts from sweep mode to repeat mode.

Saving Sweep Mode Settings. You can save sweep mode settings in mass storage by selecting a memory location and pressing the SAVE button during the sweep. Refer to “Memory and Mass Storage” on page 2–50 for more information on saving settings.

Table 2-5: Controls that do not defeat Sweep Mode

Control Group	Specific Control
Setup	SAVE
Memory	Index Selection Buttons
Display	REF, ENTER
Cursor	Mode Selection Buttons, Position Buttons
GPIB	REST TO LOCAL, USER REQUEST

Saving Sweep Mode Data. Like other displays, you can save sweep mode displays in mass storage by pressing the display ENTER button during the sweep. All data captured up to the point you pressed ENTER are stored at the memory location you specified, and the sweep continues. When the setting is recalled, sweep mode is automatically selected by the 371B. Refer to “Memory and Mass Storage” on page 2-50 for more information on saving settings.

Device Characteristics Display

The CRT displays the effect the collector supply and step generator signals have on the DUT.

Refer to Figure 2-17. The display screen has two basic display areas: the curve setup area and the reference curve display area.

Curve Setup Area

This area consists of a display column that provides individual readouts for VERT/DIV, HORIZ/DIV, PER STEP, OFFSET, or gm/DIV, % of COLLECTOR PEAK VOLTS, and cursor measurement readouts. When the reference curve is displayed, readout data of the store or view curve are displayed. Additional operating details are provided in “Operating Exercises” on page 3-2 and in “Measurement Exercises” on page 3-17.

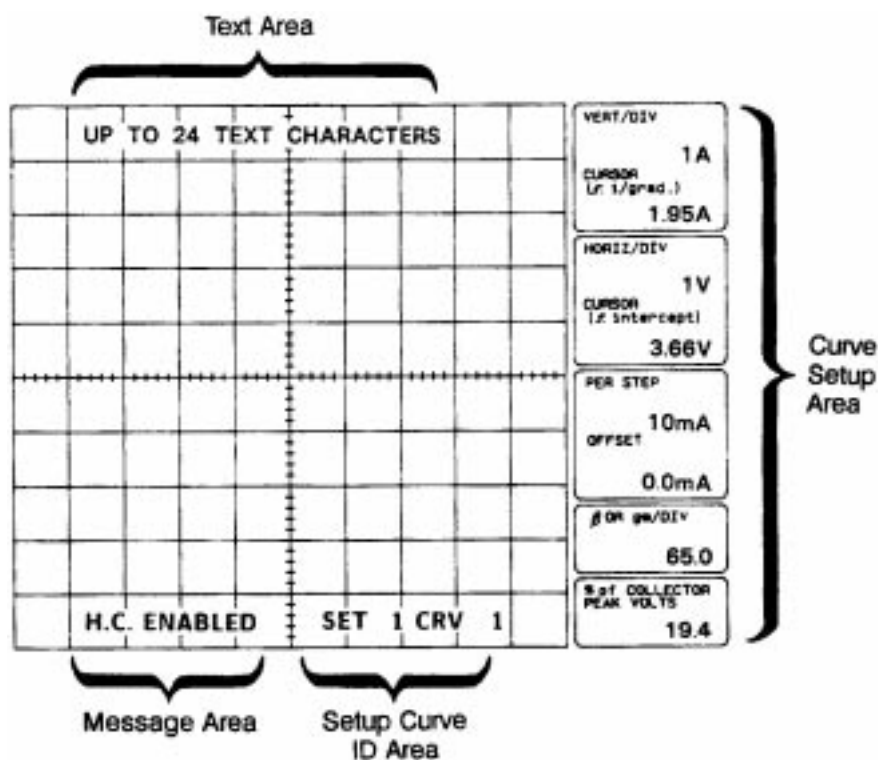

Figure 2-17: Display screen and its display areas

Curve Display Area

This area consists of a 10 X 10 grid in which the measurement curve and text may be displayed. Text areas are provided within the top-most and bottom-most vertical grids to display text for the following purposes:

- Text area
- Setup/curve area
- The vertical axis
- The horizontal axis

Text Area. You can enter up to 24 characters in this area. Text is useful for identifying specifications or device type. Text may be stored and recalled with setups and curves.

Text entry is made using the display controls and the cursor SHIFT button. A text editing exercise is provided in “Operating Exercises” on page 3-2.

Message Area. Messages up to 14 characters (such as OPERATION ERR, SAVE COMPLETE, CHECKSUM ERROR, etc.) are displayed in the bottom left corner of the 10 X 10 grid. These messages are displayed for about five seconds and then automatically erased. Refer to “Messages” on page C-7 for a complete list of messages.

Setup/Curve ID Area. This area in the bottom-right corner of the 10 x 10 grid displays text that identifies the memory location of the currently displayed reference curve and display setup (the setup ID). To display the memory location of the currently displayed reference curve, press the VIEW button. To display the memory location of the current display setup, press the RECALL button.

The Vertical Axis. The vertical axis shows the current flowing through the COLLECTOR/DRAIN/ANODE connector on the adapter panel. Vertical axis sensitivity is set by the VERTICAL CURRENT/DIV (vertical current per division) knob. The range of available settings depends on the setting of the collector supply peak power watt buttons as listed in Table 2-6.

Table 2-6: Vertical Axis Display Settings

Peak Power Watts Setting	VERTICAL CURRENT/DIV Setting Range
3 kW	1 A/div to 50 A/div
300 W	500 mA/div to 5 A/div
30 W	100 μ A/div to 5 mA/div
3 W	10 μ A/div to 500 μ A/div
300 mW	10 μ A/div to 500 μ A/div
30 mW	1 μ A/div to 50 μ A/div

The selected vertical sensitivity is displayed in the VERT/DIV (vertical per division) display area on the CRT.

The Horizontal Axis. The horizontal axis shows the voltage between either the COLLECTOR/DRAIN/ANODE and COMMON connectors or between the BASE/GATE and COMMON connectors of the patch and adapter panels. Voltage sensitivity is set by the HORIZ VOLTS/DIV (horizontal volts per division) control as follows:

When turned an appropriate number of positions clockwise, the HORIZ VOLTS/DIV control selects the collector measurement (V_{CE}) and sets the horizontal sensitivity in one of the ranges listed in Table 2-7.

Table 2-7: Horizontal Sensitivity Ranges

Peak Power Watts Setting	HORIZ VOLTS/DIV Setting Range
3 kW/300 W	100 mV/div to 5 V/div
30 W/3 W	50 mV/div to 500 V/div
300 mW/30 mW	5 mV/div to 50 V/div

When turned an appropriate number of positions counterclockwise, the HORIZONTAL VOLTS/DIV knob selects the STEP GENERATOR (V_{BE}) measurement and sets the horizontal sensitivity in the range of 100 mV/div to 5 V/div.

The selected horizontal sensitivity is displayed in the HORIZ/DIV readout area of the curve setup display.

Display Modes

The 371B displays characteristic curves in one of four modes; non-store, store, view, and reference. The particular mode you choose depends on the measurement application.

Non-Store Display Mode

To enter non-store display mode, press the display NON-STORE button. The characteristic curve is displayed in realtime on the display screen. This mode can be used to observe rapid variations in a waveform.

NOTE. *You cannot save a displayed curve to mass storage when in the 371B is in non-store display mode.*

Store Display Mode

This is the default (power-up) display mode. It can also be entered from one of the other display modes by pressing the display STORE button.

When the 371B is in store display mode, the characteristic curve is first digitized, stored in main memory, then reconverted to analog signals for display on the display screen. The display settings, readout values and any displayed text are also displayed. You can save the stored characteristic curve (with readout values and any displayed text) in mass storage by pressing the display ENTER button.

View Display Mode

View display mode allows you to display a saved curve from mass storage. A saved curve is displayed by selecting its memory location number, then pressing the display VIEW button.

NOTE. *The intensity of the characteristic curve when in non-store, store, or view modes is controlled with the NON-STORE/STORE/VIEW intensity knob.*

Reference Display Mode

The 371B has a portion of memory allocated for a reference waveform. When the display REF (reference) button is pressed, the currently displayed store or view mode waveform is saved in reference waveform memory. This waveform becomes a reference which remains displayed on the display screen even when the display mode is switched between store and view modes. Thus, the reference display mode can be used to:

- Compare a “live” curve with a previously saved curve
- compare two previously saved curves

This display mode is useful for matching semiconductors for similar characteristic curves, as well as for other curve comparison applications. The intensity of the reference curve is controlled with the REF INTENSITY knob; the intensity of the store and view curves is controlled with the NON-STORE/STORE/VIEW INTENSITY knob. Since these are two different controls, you are able to set a different intensity for the reference and comparison curves for easy identification.

The reference curve remains displayed until the REF button is pressed again, or non-store display mode is selected.

The “Measurement Exercises” on page 3–17 demonstrate how to use the reference display mode.

Display Cursors

The 371B has three types of display cursors which help make precise measurements: a window cursor, a dot cursor, and an f line cursor. Table 2–8 lists the relationships of these cursors.

Table 2–8: Relationships between Cursors and Readout display

Cursor Mode	Display Mode	β or gm/DIV readout display	Cursor Readout Display	
			(f: 1/gradient)	(f: intercept)
Off	all	β or gm/DIV		
Window	all	$\beta \Delta I_C \Delta I_B$ or gm $\Delta I_D \Delta V_{GS}$	Current at bright dot position	Voltage at bright dot position
Dot	store, view	High Current Mode: I_C/I_B or I_D/V_{GS} High Voltage Mode: β or gm/DIV	Current at cursor position	Voltage at cursor position
f line	store, view	β or gm/DIV	On-state resistance (HORIZONTAL is in COLLECTOR range) or gm (HORIZONTAL in STEP GEN range)	Voltage at which the cursor intercepts the horizontal axis.

Window Cursor

The window cursor is displayed as a rectangle with a bright dot in either the bottom left or top right corner, as selected by the cursor mode selection buttons. The cursor position buttons change the size of the window. The window cursor can be used to check visually that the characteristics of a DUT are within a specific range.

A stored window with a front-panel setup can be recalled from memory and used to provide a visual pass/fail reference for a measured device. It can also be used to measure the $\beta \Delta I_C \Delta E_B$ on the curve of the collector current versus collector/emitter voltage of a transistor. It can also be used to measure the gm $\Delta I_D \Delta V_{GS}$ on the curve of the drain current versus drain/source voltage of an FET.

The current and voltage values at the position of the bright dot are displayed in the CURSOR readout area on the display screen. When the bottom left dot and top right dot are positioned on two adjacent curves, respectively, the hfe or gm value is displayed in the β or GM/DIV readout area. Demonstrations on how to use the window cursors are provided in “Measurement Exercises” on page 3–17.

The window cursor can be used in non-store as well as store mode, and it can be displayed at any point on the screen.

Dot Cursor The dot cursor is an intensified spot that can be positioned at any point on a characteristic curve. This cursor displays the current and voltage values at its position on the characteristic curve. These values are displayed in the appropriate readout area. In high-current operation, DC current gain (I_C/I_B) or DC forward transfer admittance (I_D/V_{GS}) at the cursor position is displayed in the β or gm/DIV readout. Demonstrations on how to use the dot cursor are provided in “Measurement Exercises” on page 3–17.

f Line Cursor The f line cursor is displayed as a straight line that passes through the dot cursor position. Its slope can be varied by the four cursor position buttons (up, down, left, and right). The f line cursor is useful for measuring the on-state resistance of a device and for measuring the forward transfer admittance of FETs.

When COLLECTOR (V_{CE}) is displayed on the horizontal axis, the CURSOR (f:1/grad) readout area on the display indicates the resistance ($\Delta V_{CE}/\Delta I_C$), while the CURSOR (f:intercept) readout area indicates the voltage value at which the f line cursor intercepts the horizontal axis.

When STEP GEN (V_{BE}) is displayed on the horizontal axis, the CURSOR (f:1/grad) readout indicates the forward transfer admittance ($\Delta I_D/\Delta V_{GS}$) while the CURSOR (f:intercept) readout indicates the voltage value at which the f line cursor intercepts the horizontal axis.

Demonstrations on how to use the f line cursor are provided in “Measurement Examples” on page 3–17.

Text Editing

The 371B has a text editing mode for adding or modifying displayed text. Text is useful for labeling characteristic curve displays for ease of identification and to note conditions by which the measurement was obtained. Text is stored, in mass storage, along with the characteristic curve or setup information.

Text consists of a full range of uppercase alpha characters, numbers, and symbols. Up to 24 characters can be displayed in the upper part of the display screen.

Using Text Edit Mode The following is a description of the functions associated with text edit mode. These functions are summarized in Table 2–9.

Initiate Text Edit Mode. To initiate text edit mode, hold down the cursor SHIFT button, then press the ENTER button. The TEXT EDIT MODE message is displayed at the bottom of the display area (for about five seconds), and the text edit cursor is displayed at the first character position of the text edit display area. The 371B is ready for text entry.

Position Text Cursor. To position the text cursor to one of the 24 character positions, press the right or left cursor position buttons.

Select a Character. To select an alphanumeric or symbol character, press the up cursor button to move forward through the character string, or press the down cursor button to move backward through the character string. Once displayed, characters remain in position until they are either over-written or erased.

Erase a Character. To erase a displayed character, position the text cursor over the character to be erased, then press the cursor SHIFT button. The cursor then moves to the next character position. To erase all text under and to the left of the cursor, simultaneously press the left and right cursor buttons. Text is erased and the cursor with all text to the right of the cursor moves to the left, with the cursor moving to the left-most position of the text string.

Exit Text Edit Mode. To exit text edit mode without saving text changes, press either the STORE or NON-STORE buttons. All displayed text is erased and the message TEXT CANCELED is displayed.

To exit text edit mode and save text changes, press the ENTER button (also saves a displayed characteristic curve). Text edit mode ends and the 371B returns to normal operation.

Text can also be saved as follows:

- To save text with front-panel setup information, press the SAVE button
- If text was entered when in view mode, text is automatically saved upon exiting view mode

Display a Directory of Stored Text. To display a directory of stored text, hold down the cursor SHIFT button, then press the RECALL button. Refer to “The File Directory” on page 2–52 for details.

Table 2–9: Summary of Text Editing Functions

Function	Action
Initiate Text Edit Mode	Hold down cursor SHIFT button, then press ENTER button.
Position text cursor	Press the right or left cursor buttons depending on the direction you want to move the cursor.
Select a character or symbol	Press the up or down cursor buttons to move forward or backward through the string of displayable characters and symbols. Characters and symbols are displayed at the text cursor position.
Erase a character or symbol	Use the right or left cursor buttons to position the text cursor on the desired character, then press the cursor SHIFT button.
Erase all text under and to left of cursor	Simultaneously press the right and left cursor buttons.
Exit without saving	Press either the STORE or NON-STORE buttons.
Exit and save	Press the ENTER button.
Save text with front-panel setup information	Press the SAVE button.
Display directory of stored text	Hold down the cursor SHIFT button, then press the RECALL button.

Memory and Mass Storage

The 371B mass storage system consists of non-volatile memory and a 3.5 inch floppy disk drive. This system is used to store both characteristic curve data (with display settings, readout values, and displayed text) and front-panel settings.

Figure 2–18 shows how memory is structured. There are a total of 80 memory locations for storing characteristic curves and 80 memory locations for storing front-panel settings. Non-volatile memory holds 16 characteristic curves and 16 front-panel settings, while the floppy disk holds 64 characteristic curves and 64 front-panel settings. Typically, you would store a characteristic curve and its corresponding front-panel settings in separate memory locations of the same number.

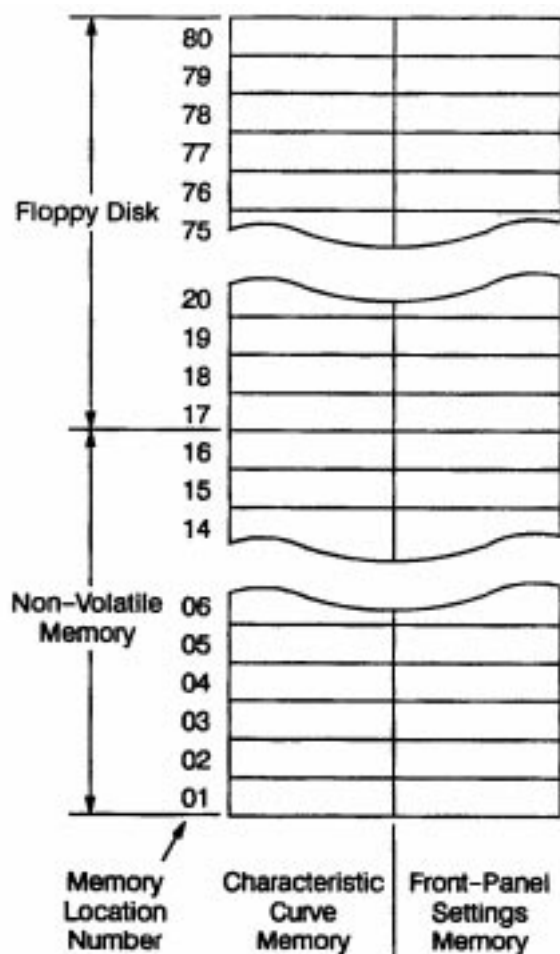

Figure 2-18: 371B memory structure

The following information describes how to

- use the file directory
- select a memory location
- save and recall front panel setting files
- enter and view acquired characteristic curve files
- copy files from non-volatile memory to floppy disk
- copy files from floppy disk to non-volatile memory
- erase non-volatile memory
- transfer data between the 371B and external devices

You can then sequence through the pages of the file directory as described above, with pages alternating between curve and setup files locations. Use the memory up button to move up in the directory and the memory down button to move down in the directory pages. Odd numbered pages describe memory contents for characteristic curve files; even numbered pages for front-panel setup files.

If there is no data stored in the memory location indicated by the memory location number, a <NVM DATA EMPTY> for locations 1 to 16, and <FD DATA EMPTY> for locations 17 to 80 is displayed in place of the file name. If an attempt is made to display the directory for memory location numbers in the range of 17 to 80 when there is no disk in the disk drive, a <FD NOT READY> is displayed in place of the file name.

When you have sequenced to the last page of the file directory, the word END appears at the bottom left corner of the page.

To reset to page one of the file directory, simultaneously press the memory up and down buttons.

To exit directory display, press any front-panel button or switch other than MEMORY, SAVE, RECALL, or cursor SHIFT.

Select a Memory Location

The memory up and down buttons are used to select a memory location (01 to 80) in which to save or read a curve or setup file. The memory location number is displayed in the LED readout to the left of the memory down button.

Data is directed to be read to or from a selected memory location depending on which front-panel button you press.

Save and Recall Front Panel Setting Files

Saving front panel settings enables you to store desired setups for use at some future time. Once saved, you can retrieve (recall) the file to quickly preset the front-panel controls to settings defined by the file.

The setup SAVE and RECALL buttons allow you to save or recall a group of front panel settings. All of the front panel settings except those listed in Table 2–10 can be stored in and recalled from memory.

Table 2-10: Controls that cannot be stored in Mass Storage

Control Group	Specific Control
Collector Supply	LOOPING COMPENSATION
DISPLAY	ENTER
Setup	RECALL, SAVE
Memory Location	Memory location buttons
CRT Controls	INTENSITY, FOCUS, GRAT ILLUM, POSITION , TRACE ROTATION
GPIB	RESET TO LOCAL

To save front-panel settings, select the desired memory location number, then press the SAVE button. The front panel settings, along with any user-entered text, are saved at the selected memory location number.



CAUTION. *Saving to a memory location overwrites with new data. Therefore, before saving a file to a memory location, check the memory location using the file directory feature. Make sure that the memory location does not contain a setup file that you may need.*

To recall a file containing front-panel settings, select the desired memory location number then press the RECALL button.

NOTE. *If the position of the collector supply HIGH VOLTAGE breaker and HIGH CURRENT breaker is not the same as when the front-panel settings were originally saved, the message H.V. UNMATCH, or H.C. UNMATCH, or H.C. UNMATCH is displayed. You must switch the unmatched breaker, and press the RECALL button once again.*

To save the sweep mode setting, press the SAVE button. The final value of the collector supply or step generator output is also stored.

Enter and View Acquired Characteristic Curve Files

To enter (save) an acquired characteristic curve when operating in store, view, or sweep modes, select the desired memory location number, then press the ENTER button. Display settings, readout values, and displayed text are also saved.

To view (read) a characteristic curve and associated information from a memory location, select the desired memory location number, then press the VIEW button.

Copying Files from Floppy Disk to Non-Volatile Memory

The 371B allows you to copy simultaneously up to 16 characteristic curves and up to 16 front-panel setups from floppy disk to non-volatile memory. You are able to perform tests more quickly when working files are being read from non-volatile memory rather than from directly from the floppy disk.

The following example describes how you would use this feature:

1. Select the floppy disk memory location number from which you wish to begin copying to non-volatile memory. For example, if you select memory location 24, index locations 24 – 39 will be copied to memory locations 1–16, respectively.

2. Hold down the cursor **SHIFT** button and then press the **SINGLE** button.

Observe that the message “PRESS SINGLE floppy → NVM” is displayed for about five seconds.

3. Press the **SINGLE** button once again while the message “PRESS SINGLE Floppy → NVM” is displayed. (Failure to do so within about five seconds causes the message “COPY CANCELED” to be displayed and the copying function is canceled.)

Copying occurs by first copying all 16 characteristic curve locations and then copying all 16 front-panel setup locations.

Curve data is read from the specified memory location (location 24, in this example) and copied to non-volatile memory location 1, then from index location 25 to memory location 2, and so on. Copying of curve data is terminated when all 16 curves are copied from floppy disk to non-volatile memory. If non-volatile memory contains less than 16 stored curves, or memory location 80 is reached before 16 curves are copied, curve copying is completed when the last stored curve is copied to floppy disk.

When curve copying is completed, the 371B begins copying front-panel setups following the same sequence as for curves.

During the copy process, the number displayed by the memory LED display indicates the memory location to which the curve or front-panel setup is being copied.

Copying Files from Non-Volatile Memory to Floppy Disk

The 371B allows you to simultaneously copy up to 16 characteristic curves and up to 16 front-panel setups from non-volatile memory to the floppy disk.

The following example describes how you would use this feature:

1. Select the floppy disk memory location number to which you wish to copy the non-volatile memory contents. For example, if you select location 24, memory contents will be copied to memory locations 24–39.
2. Hold down the cursor **SHIFT** button and then press the **REPEAT** button.

Observe that the message “PRESS REPEAT NVM → Floppy” is displayed for about five seconds.

3. Press the **REPEAT** button once again while the message “PRESS REPEAT NVM → Floppy” is displayed. (Failure to do so within about five seconds causes the message “COPY CANCELED” to be displayed and the copying function is canceled.)

Copying occurs by first copying all 16 characteristic curve locations and then copying all 16 front-panel setup locations.

Curve data is read from index location 1 and copied to the specified index location (index 24, in this example), then from index location 2 to index location 25, and so on. Copying of curve data is terminated when all 16 curves are copied from non-volatile memory to floppy disk. If non-volatile memory contains less than 16 stored curves, or index location 80 is reached before 16 curves are copied, curve copying is completed when the last stored curve is copied to floppy disk.

When curve copying is completed, the 371B begins copying front-panel setups following the same sequence as for curves.

During the copy process, the number displayed by the memory LED display indicates the memory location to which the curve or front-panel setup is being copied.

Erasing Non-Volatile Memory



CAUTION. *The following operation erases all data stored in non-volatile memory (the first 16 memory locations), not just the data stored in the currently indicated memory location number. Do not perform this operation unless you really want to erase all data stored in non-volatile memory.*

To erase all data stored in non-volatile memory, hold down the cursor SHIFT button then press the display INVERT button. The message PRESS INVERT is displayed for about five seconds. Immediately press the INVERT button again before the message PRESS INVERT disappears from the display screen (you have about five seconds). If the INVERT button is not pressed during the time the message PRESS INVERT is displayed, the formatting function is aborted (the message “ERASE CANCELED” is displayed) and the 371B returns to normal operating mode.

Data Transfer with External Devices

You can transfer data files between the 371B and external devices via the General Purpose Interface Bus (GPIB). Refer to “GPIB” chapter on page 4–1 for detailed information regarding GPIB functions.

Disk Formatting

A floppy disk must be formatted before it can be used in the 371B. A “371B” volume label is written and a “371B” sub-directory is made on the disk formatted on the 371B. For a description of how data is formatted, refer to the CURve? query command in “GPIB” chapter.



CAUTION. *Formatting a disk destroys all data stored on the disk. Make sure you no longer need the data before you format the disk.*

NOTE. *If you attempt to format a disk with the write protect tab set at the write protect position, the message WRITE PROTECT appears at the bottom of the CRT, and the formatting function is canceled.*

To format a disk, insert the disk into the disk drive. Then while holding down the cursor SHIFT button, press the SAVE/FORMAT button. The message “PRESS SAVE” is displayed for about five seconds. Immediately press the SAVE button again before the message “PRESS SAVE” disappears from the display screen. (You have about five seconds.) If the SAVE button is not pressed during the time the message “PRESS SAVE” is displayed, the formatting function is aborted (the message “FORMAT ABORTED” is displayed) and the 371B returns to normal operating mode.

While disk formatting is in progress, the message “NOW FORMATTING” is displayed at the bottom left of the display screen and the number of the track currently being formatted is displayed in the memory index display. When the track number reaches 79, formatting is completed, the message “DISK FORMATTED” is displayed, and the 371B returns to the preselected operating mode.

Floppy Disk Handling

The 371B can read/write 2HD floppy disk and can read 2DD floppy disk.

The 3.5 inch floppy disks are easy to handle and store. However, observe the following precautions to protect the disk and the integrity of the stored data.



CAUTION. *Do not expose the floppy disks to strong magnetic fields, and do not place them near strongly ferromagnetic material that can be easily magnetized. If these cautions are not observed, data may be destroyed, or errors may occur.*

Do not expose floppy disks to direct sunlight or high temperatures for long periods of time. Also, avoid storing floppy disk in extremely cold or humid environments. Prolonged exposure to such environmental conditions will damage floppy disks.

It is important to place the floppy disks back in their cases for long-term storage to avoid prolonged exposure to dust and other contaminants.



Reference

Reference

Information in this chapter provides a sequence of exercises designed to acquaint the first-time user with the basic procedures required to perform device measurements and setups. These exercises are divided into two groups: Operating Exercises which acquaint you with 371B controls and related functions and, and Measurement Exercises which acquaint you with the fundamentals of performing semiconductor device measurements.

NOTE. *These procedures do not verify that the 371B meets the performance specifications listed in Appendix A. To verify that the 371B meets performance specifications, a qualified technician must perform the procedures provided in the 371B Service manual.*

Operating Exercises

These exercises acquaint you with how the 371B displays, captures, and analyses semiconductor test data. Here you will find a description of the 371B power-up sequence. Following a successful power-up (during which diagnostics are automatically run), you have reasonable assurance that the 371B will perform measurements as specified and described in this manual.

These procedures are designed to acquaint the first-time user with control operations used to obtain and analyze semiconductor performance information with the 371B. After you have performed these procedures, you will be ready to work through the measurement exercises.

Operating exercises are presented in the following order:

- Powering-up the 371B and storing power-up default settings.
- Exercising display controls.
- Checking the calibration reference voltage and display invert feature.
- Exercising setup, save, and recall features.
- Exercising vertical and horizontal sensitivity controls.
- Exercising text editing features.
- Formatting floppy disks.
- Verifying floppy disk operation.
- Displaying the memory directory.
- Erasing non-volatile memory.
- Hardcopy and save the CRT image.

NOTE. *These procedures assume that the test fixture unit is connected to the 371B and that the 371B is connected to a power source as described on page 1–6.*

Powering-Up the 371B and Storing Power-Up Default Settings

This procedure describes the power-up sequence and how to store the power-up default settings for use in various procedures throughout this chapter.

1. Set the collector supply **HIGH VOLTAGE** and **HIGH CURRENT** breakers to the **DISABLED** position.
2. Set the 371B **POWER** switch to **ON**.

The 371B automatically begins performing a self-test routine. This sequence takes about 5 seconds. If the Power-on Diagnostics detect no error, the message “SELFTEST PASS” is displayed on the error message area of the CRT. The 371B then configures to the default setup. Table 3-1 lists the default conditions of the 371B. The CRT controls and LOOPING COMPENSATION control are not set at power-up.

If the 371B detects the low voltage of the internal Lithium battery, the message “BATTERY IS LOW” is displayed. Although you can operate the 371B, you are recommended to call the sales representative to ask the battery replacement.

3. Allow the instrument to warm up for a few minutes before proceeding.
4. Press the **SAVE** button to store the default settings in memory location 1. These default settings are used as a starting point for each major step throughout the following procedures.

Table 3-1: Default Setup

Control	Default Setting
Measurement Mode	REPEAT
MEMORY Index	1
Display	
Mode	STORE
VERTICAL CURRENT/DIV	1 A
HORIZONTAL VOLTS/DIV	COLLECTOR V_{CE} 1 V
INVERT	OFF
VARIABLE	0.0 %
Cursor	OFF
Collector Supply	
PEAK POWER WATTS	HIGH CURRENT 300 W
POLARITY	NPN
Step Generator	
SOURCE	CURRENT
AMPLITUDE	1 mA
INVERT	OFF
NUMBER OF STEPS	2
OFFSET	0.0 MA
STEP MULT.1X	OFF
GPIB	
LOCAL/REMOTE	LOCAL (LED OFF)
SRQ	SRQ Power ON
Collector Supply Knobs (on instrument porch)	
Variable knob	0.0%
Looping Compensation	mid-range

Exercising the Display Controls

The following steps demonstrate the effects of the CRT display controls and how to adjust them for optimum display viewing.

1. Turn the **NON STORE/STORE/VIEW INTENSITY** control clockwise until a spot appears at the bottom left corner of the CRT graticule. To avoid burning the CRT phosphor, adjust the **NON STORE/STORE/VIEW INTENSITY** control until the spot is just visible.

2. Turn the **FOCUS** control throughout its range. Adjust the **FOCUS** control for a well-defined spot.
3. Turn the **READOUT/CURSOR INTENSITY** control throughout its range. Note that the readout becomes brighter as the control is turned clockwise. Set the control for the desired readout brightness.

The initial displayed control settings should be displayed as listed in Table 3–2.

Table 3–2: Display Area Readout at Power-Up

Readout Area	Reading
VERT/DIV	1 A
CURSOR (f: 1/grad)	none
HORIZ/DIV	1 V
Cursor (f: 1/intercept)	none
PER STEP	1 mA
OFFSET	0.00 mA
β or gm/DIV	1 K
% of COLLECTOR PEAK VOLTS	0.0

4. Turn the **GRAT ILLUM** control throughout its range. Note that the graticule lines and the readout titles brighten as the control is turned clockwise. Set the control for desired illumination.

Setting Date and Time

The date and time is printed when you output a CRT image to the printer or when you save a CRT image into the floppy disk.

1. Press the cursor **SHIFT** button while holding the **MEMORY UP** and **DOWN** button simultaneously to enter the date and setting mode.
2. Press the **POSITION RIGHT** and **LEFT** button to move the cursor to the item you want to change.

You can only select the first digit. The tenth digit will be automatically rose in rank.

3. Press the **POSITION UP** and **DOWN** button to change the value.

You can set the year from 2000 until 2099, and set the time in 24 hours. The second will be reset to zero when you exit the date and time setting mode.

4. Press the cursor **SHIFT** button to exit the date and time setting mode.

Checking the Calibration Reference Voltage and Display Invert Feature

These steps demonstrate the use of the CAL ZERO (calibration zero) and CAL FULL (calibration full) controls to check display calibration. The effect of the display INVERT control is also demonstrated.

1. Select the dot cursor.
2. Hold down the cursor **SHIFT** button, then press the **VIEW** button. This sets the 371B to zero calibrate (CAL ZERO) operation.

Note that the displayed dot is located on or near the bottom left corner of the display graticule and the word CAL is displayed in the top right corner.

3. Turn the vertical screwdriver **POSITION** control to align the displayed dot with the bottom graticule line.
4. Turn the horizontal screwdriver **POSITION** control to align the displayed dot with the left-most graticule line.

The displayed dot should now be positioned directly on the bottom left corner of the CRT graticule.

5. Check that the VERT CURSOR readout does not exceed ± 0.02 A. Check that the HORIZ CURSOR readout does not exceed ± 0.02 A.

The zero calibrate feature provides a reference voltage for checking the calibration voltage at the bottom left corner of display graticule.

If vertical or horizontal readouts exceed the values listed above, refer a qualified technician to “Examining Calibration Voltage” in the 371B Service manual.

NOTE. *Failure of the instrument to meet the functional characteristic stated above will not prevent you from being able to continue with these operating exercises.*

6. Hold down the cursor **SHIFT** button, then press the **STORE** button. This sets the 371B to full calibrate (CAL FULL) operation.

Note that the displayed dot is located at the top right corner of the display graticule.

7. Check that the VERT CURSOR readout is between 9.98 A and 10.02 A. Check that the HORIZ CURSOR readout is between 9.98 A and 10.02 A.

The full calibrate feature provides a reference voltage for checking the calibration voltage at the top-right corner of display graticule.

If the vertical or horizontal readouts exceed the values listed above, refer a qualified technician to “Examining Calibration Voltage” in the 371B Service manual.

NOTE. Failure of the instrument to meet the functional characteristic stated above will not prevent you from being able to continue with these operating exercises.

8. Hold down the cursor **SHIFT** button, then press the **REF** (reference) button. This sets the 371B back to normal operation (CAL OFF).
9. Press the display **INVERT** button.
10. Observe that the dot is displayed in the top right corner of the display graticule.
11. Press the display **INVERT** button once again to resume normal operation.

Exercising Setup Save and Recall Features

These steps demonstrate the ability of the 371B to save and recall front-panel setups.

1. Press the memory up button to select memory location **4**.
2. Set front panel controls as follows:

Display

VERTICAL CURRENT/DIV 5A

HORIZONTAL VOLTS/DIV 200 mV

Step Generator

STEP/OFFSET AMPLITUDE 10 mA/Step

Collector Supply

POLARITY PNP– (note that step generator
INVERT indicates NEG–)

Note the corresponding changes in the display readouts on the CRT.

3. Press the setup **SAVE** button.
4. Change any or all of the controls that were set in Step 2 to different settings.
5. Press the setup **RECALL** button and note that front-panel settings are reset to the settings saved in Steps 2 and 3.
6. Simultaneously press the up and down memory buttons. Note the the memory location number is set to **1**.
7. Press the **RECALL** button to reset the initial power-up control settings.

Exercising Vertical and Horizontal Sensitivity Controls

These steps demonstrate the operation of the vertical and horizontal sensitivity controls. This exercise requires that a 1 Ω resistor with at least a 4 W rating be installed in the test fixture unit.

Test Fixture Unit Setup. The 1 Ω resistor can be installed in the test fixture unit using an optional A1005 test adapter, or it can be connected using patch cords as described in the following steps.

1. Obtain a 1 Ω resistor with at least a 4 W rating.
2. Open the protective cover on the test fixture unit. If using the A1005 test adapter, perform Step 3. If using patch cords, perform Step 4.

NOTE. For details about the patch panel and the adapter panel, refer to the discussion under “Device Connection” on page 2–32.

3. If using an A1005, proceed as follows:
 - a. Insert the A1005 test adapter into the test adapter connector on the adapter panel.
 - b. Connect the patch cords between connectors on the patch panel and the adapter panel as shown in Figure 3–1.
 - c. Close the protective cover.
4. If you are using patch cords, perform the following:
 - a. Remove the adapter panel as described under “Device Connection” on page 2–32.
 - b. Using patch cords with alligator clips, connect the 1 Ω resistor to the test fixture connectors as follows:
 - Connect the **COLLECTOR SUPPLY HIGH CURRENT** and **COLLECTOR SUPPLY HIGH CURRENT SENSE** to one end of the resistor.
 - Connect the **COMMON** and **COMMON SENSE** to the other end of the resistor.
 - c. Close the protective cover on the test fixture unit.

Proceed with the following control exercises.

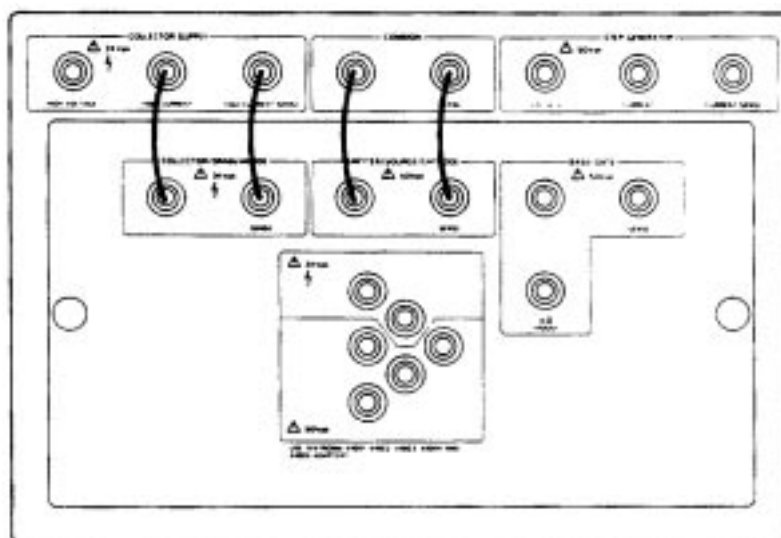

Figure 3-1: Patch cord connections for vertical and horizontal sensitivity exercise

Exercising the Controls. The following steps use the test fixture unit setup as described in the preceding four steps.

1. Set the collector supply **HIGH CURRENT** breaker to the **ENABLED** position.
2. Slowly rotate the collector supply **VARIABLE** knob clockwise.
Observe that the dot on the screen moves along a diagonal line from the bottom left corner to the top right corner of the display graticule.
3. Rotate the collector supply **VARIABLE** knob counterclockwise to move the dot to the center of the display.
4. Rotate the **VERTICAL CURRENT/DIV** knob clockwise, increasing vertical sensitivity.
Observe that the dot moves upward.
5. Rotate the **VERTICAL CURRENT/DIV** knob counterclockwise until the sensitivity is set to **5 A/div**.
Observe that the dot moves downward.
6. Return the **VERTICAL CURRENT/DIV** knob to the **1 A/div** setting.
7. Rotate the **HORIZONTAL VOLTS/DIV** knob clockwise, increasing horizontal sensitivity.
Observe that the dot moves to the right.

8. Turn the **HORIZONTAL VOLTS/DIV** knob counterclockwise until the sensitivity is set to **5 V/div**.

Observe that the dot moves to the left.

9. Return the **HORIZONTAL VOLTS/DIV** knob to the **1 V/div** setting.

10. Press the display **INVERT** button.

Observe that the red **INVERT** light turns on.

11. Rotate the collector supply **VARIABLE** knob clockwise.

Observe that the dot moves toward the bottom left when the knob is turned clockwise and toward the top right when the knob is turned counterclockwise.

The origin of the graticule is now in the top right corner and the direction of dot movement is the inverse of normal operation.

12. Continue with the following exercise.

Checking Vertical Sensitivity in High Current Mode. These steps demonstrate vertical sensitivity characteristics in high current mode.

1. Observe that the memory location number is **1**, then press the setup **RECALL** button to initialize the 371B.

2. Select the dot cursor.

3. Rotate the collector supply **VARIABLE** knob to move the dot to the approximate center of the display.

Note the current reading in the VERT/DIV readout area of the CRT.

4. Press the collector supply peak power watts **3 kW** button.

5. Turn the **VERTICAL CURRENT/DIV** knob clockwise until the sensitivity is set to **1 A/div**.

6. Observe that the current for the 3 kW setting increases from its previous position (noted in Step 3) for 300 W (default) setting.

7. Set the collector supply **HIGH CURRENT** breaker to the **DISABLED** position, then open the protective cover.

8. Remove the resistor from the test adapter or from the patch cords, and close the protective cover.

Exercising Text Editing Feature

This procedure demonstrates how text is entered and saved by the 371B. As explained on page 2–48, user-entered text is useful for identifying characteristic curve displays and setups that are stored and recalled for later use.

1. Hold down the cursor **SHIFT** button and then press the **ENTER** button. You are now in text entry mode.

The message TEXT EDIT MODE is displayed for about five seconds, and the blinking text cursor appears in the left-most character position of the 24-character text line at the top of the display.

2. Alternately press and release the up cursor position button and observe that characters are displayed at the cursor position in the following sequence.
space A B ... Z SPACE m u n p . 1 9 - / * () =

NOTE. *The 371B substitutes the Greek letter “μ” for the lower-case “u”.*

Once displayed, characters remain in place until written over or erased, as described below.

3. Press either the right or left cursor button to move the cursor to a different character position. Observe that the text cursor moves without altering the displayed text. (The cursor wraps around to the opposite end of the text line when moving past either end.)
4. Use the four cursor position buttons to enter any desired text string of up to 24 characters.
5. Move the cursor to the middle of the text string.
6. Press the cursor **SHIFT** button and observe that the character at which the cursor is displayed is erased and the cursor moves to the next position on the left.
7. Simultaneously press the left and right cursor position buttons, and observe that text is deleted and that the text cursor moves to the left side of the text area.
8. Enter another text string.
9. Press the **ENTER** button to exit the text edit mode.

Observe that the text cursor disappears from the display and that the text remains as displayed.

10. Change the memory location to **3** and press the display **ENTER** button.

The entered text is now stored in memory.

11. Change the memory location to **1** and press the setup **RECALL** button. This initializes the 371B to the initial power-up settings once again.

Observe that the entered text is cleared from the display.

12. Change the memory location number back to **3**, then press the display **VIEW** button.

Observe that the previously stored text is displayed once again.

13. Change the memory location to **1** and press the setup **RECALL** button to initialize the 371B.

Formatting Floppy Disks



CAUTION. Saving to a memory location overwrites with new data. Therefore, before saving a file to a memory location, check the memory location using the file directory feature. Make sure that it does not contain a file that you may need.

1. Obtain a blank 3.5 inch floppy disk (2HD type). If the floppy disk is write-protected, move the write protect tab to the WRITE-ENABLE position (shown in Figure 3-2).

NOTE. If you attempt to format a disk with the write protect tab set at the WRITE PROTECT position, the message WRITE PROTECT appears, and the formatting function is canceled.

2. Insert the disk with the label side up (see Figure 3-3) pushing it in firmly until it clicks into place.
3. Hold down the cursor **SHIFT** button and press the **SAVE** button. Now immediately press the **SAVE** button again before the message PRESS SAVE disappears from the display screen (you have about five seconds).

NOTE. If the SAVE button is not pressed during the time the message PRESS SAVE is displayed, the message FORMAT ABORTED is displayed and the 371B returns to the preselected operating mode.

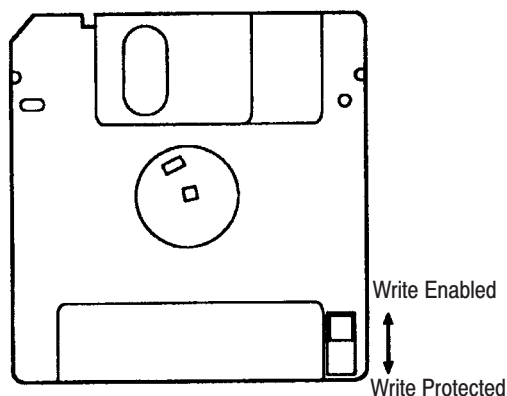

Figure 3-2: The floppy disk write-protect tab

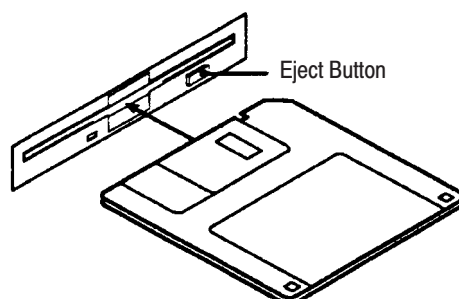

Figure 3-3: Inserting a floppy disk

Verifying Floppy Disk Operation

The following steps verify that the 371B will write to and read from a formatted floppy disk.

1. Insert a formatted floppy disk into the disk drive.
2. Set the memory location to **3** then press the display **VIEW** button.
Observe that the text entered in the preceding text editing exercise is displayed.
3. Change the memory location to **17**.
4. Press the display **ENTER** button. The disk drive indicator flashes for a short period, indicating that the text data is being written to the floppy disk.
5. Simultaneously press the memory up and down buttons to set the memory location number to **1**, then press the setup **RECALL** button to initialize the 371B.

Observe that the displayed text disappears.

6. Change the memory location number back to **17**, then press the display **VIEW** button.

Observe that the text data displayed in Step 2 is displayed once again.

7. Select memory location **1** again and press the setup **RECALL** button to reinitialize the 371B.

Displaying the Memory Directory

The following procedure demonstrates how to display a directory of memory and floppy disk contents. Refer to “Memory and Mass Storage” on page 2–50 for additional information about the 371B memory and the directory display feature.

1. Hold down the cursor **SHIFT** button and then press the setup **RECALL** button.

Observe that a partial directory (the first page) of memory contents is displayed beginning at memory location 1. (Numbers displayed by the memory location LEDs represent the number of the directory page currently being displayed.)

2. Press the memory up button and observe that the number in the memory location LED changes to represent the number for the new directory page being displayed.
3. Press the memory up button several times and note that the words – CURVE – and – SETUP – are alternately displayed as you page up (or down) through the directory.
4. To exit the directory display, use any front panel control other than memory up or down, **SAVE**, **RECALL**, or cursor **SHIFT**.

Erasing Non-Volatile Memory



The following steps describe how to erase all data stored in non-volatile memory.

CAUTION. *The following procedure erases ALL DATA stored in non-volatile memory (memory locations 1–16). Do not perform this operation if you have any important data stored in non-volatile memory.*

1. Hold down the cursor **SHIFT** button and press the display **INVERT** button. This changes the function of the **INVERT** button to erase. (Note that this function name is not printed below the button.)

The message PRESS INVERT is displayed for about five seconds.

2. Press the **INVERT** button once again before the message PRESS INVERT disappears from the display screen.

If you fail to press the **INVERT** button once again within the allotted time, the message ERASE CANCELED is displayed and the 371B returns to normal operating mode.

3. When non-volatile memory is erased, the message ERASE COMPLETE is displayed.

Hardcopy and Save the CRT Image

Hardcopy. When the **HARDCOPY/BMP FILE** button is pressed while the display mode is the **STORE** or **VIEW**, and the appropriate printer is connected to the Printer Port, the 371B initiates start of printing.

The hardcopy has date code in addition to the curve image. The indication is YYYY/MM/DD HH:SS. The operation of the hardcopy cannot be canceled while printing.

BMP File. When the **HARDCOPY/BMP FILE** button is pressed while holding the cursor **SHIFT** button, the 371B initiates making BMP file of the current screen curve image into the floppy disk. The BMP file can be made when the instrument is in Store mode only.

When in Non-Store Mode, the error message will appear on the screen. The BMP file is Monochrome bit-map data file. The file size is always 50 k bytes. The resolution is vertical: 528 dots and horizontal: 768 dots.

The file name has 8-character name with the extension of “.bmp”.

The file name will be named based on the date and time.

The file name looks like:

<M><DD><HH><MM><S>.bmp

where:

M means the month, A for January, B for February, and L for December.

DD, HH, and MM means day, hour, and minute.

S means the second and A for 00 through 09 seconds, B for 10 through 14 seconds, and F for 55 through 59 seconds.

For example:

Assume you have made a file on December 5, 13:22:15 and the file name is as below:

L051322B.bmp

CSV File. When the **HARDCOPY/BMP FILE** button is pressed while holding the **LOCAL/ADDR** button, the 371B initiates making CSV file of the current screen curve image into the floppy disk. The CSV file can be readable into EXCEL software. This file can be made when the instrument is in Store/View mode.

When in Non-Store Mode, the error message will appear on the screen. The file size is variable depending on the number of the Step of the curve, and the the maximum size will be 20 k bytes.

The file name is the same as BMP file but has the extension .csv.

The data format is as follows:

X1,Y1,<CR><LF>X2,Y2,<CR><LF>X3,Y3, X_nY_n<CR><LF>

where the maximum number of data “n” is 1024.

Measurement Exercises

This section demonstrates how to use the 371B to perform specific measurements. Here we describe how to set controls, make device connections, and interpret the displays for diode, bipolar transistors, and power MOSFET measurements. The following exercises are provided:

- Measuring forward resistance characteristics of a diode.
- Measuring breakdown voltage characteristics of a diode.
- Displaying collector current versus collector/emitter voltage characteristics of a bipolar transistor.
- Comparing an acquired curve with a reference curve.
- Measuring gain of a bipolar transistor.
- Measuring saturation voltage of a bipolar transistor.
- Measuring breakdown voltage of a bipolar transistor.
- Displaying drain current versus drain source voltage characteristics of a power MOSFET.
- Measuring forward admittance of a power MOSFET.

In the measurement examples, we will demonstrate using the dot, window, and f line cursors, as well as using other controls and 371B features that are not covered in the “Operating Exercises” earlier in this chapter.

Effects On Device Characteristics

Illustrations of displayed waveforms are provided in the following procedures. When attempting to duplicate the displays in the course of a procedure, remember that device characteristics differ and the displays depicted here will likely be different than the displayed characteristics for your DUT.

Guidelines for Using Measurement Exercises

You can use this section in one of two ways:

1. As a training exercise to familiarize yourself with the general principles of measurement methodology. You can easily progress from one exercise to the next. Start at the beginning and perform all measurement exercises in sequence.
2. To perform a specific exercise. Because each exercise contains related setup information or references to setup information, you can choose to perform only the exercise of interest.

Saving the Initial (Default) Setup

Throughout the following procedures you will be asked to “initialize” the 371B; that is, to restore the instrument to its power-up (default) control settings. One way to initialize the 371B is to cycle power off, then back on. But that’s not the best way. The best way is to save the power-up settings in memory and recall them from memory as directed in the procedures. Refer back to “Powering-Up the 371B and Storing Power-Up Default Settings” on page 3–3 for instructions on how to save settings.

Diode Measurement Exercises

These procedures demonstrate how to measure the forward resistance and breakdown voltage characteristics of a power diode.

Measuring Forward Resistance Characteristics of a Diode. This procedure demonstrates how to measure the forward resistance of a diode. The dot and f line cursors are used in this demonstration.

1. Open the protective cover on the test fixture unit.

If using the A1005 test adapter, perform Step 2. If using patch cords, perform Step 3.

NOTE. For details about the patch and adapter panels, refer to the discussion under “Device Connection” on page 2–32.

2. If using an A1005 test adapter, proceed as follows:
 - a. Insert the test adapter into the test adapter connector on the adapter panel.
 - b. Mount the diode in the test adapter (anode lead connected to top end of test adapter).
 - c. Connect the patch cords between connectors on the patch and adapter panels as shown in Figure 3–4.
 - d. Close the protective cover.

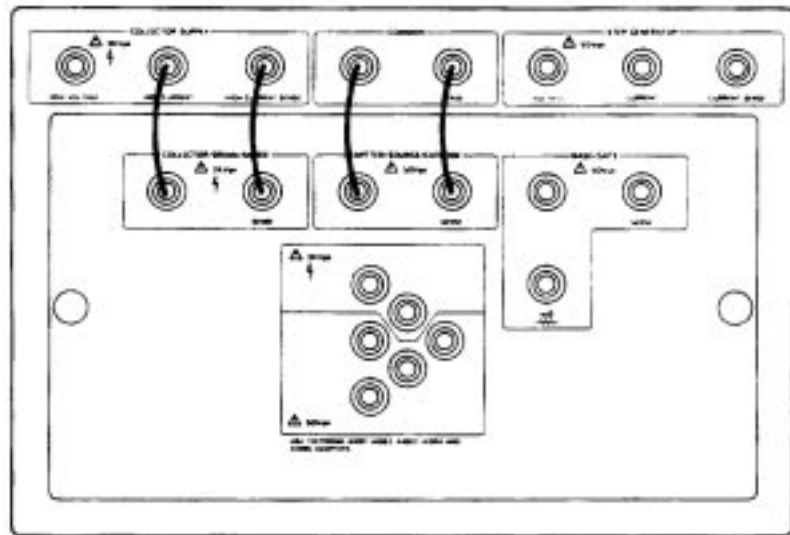

Figure 3-4: Adapter panel and patch panel connections for measuring diode forward resistance

3. If an A1005 test adapter is not available and you are using patch cords with clips, perform the following:

NOTE. When using patch cords with clips, ensure that neither the patch cord clips nor the DUT leads contact the chassis. Grounding patch cord clips or DUT leads to the chassis may damage the DUT or 371B circuit components.

- a. Remove the adapter panel as described under “Device Connection” on page 2-32.
 - b. Using patch cords with alligator clips, connect the diode to the patch panel as follows:
 - Connect the **COLLECTOR SUPPLY HIGH CURRENT** and **COLLECTOR SUPPLY HIGH CURRENT SENSE** to the anode end of the diode.
 - Connect the **COMMON** and **COMMON SENSE** to the cathode end of the diode. C. Close the protective cover on the test fixture unit.
 - c. Close the protective cover on the test fixture unit.
4. Observe that the memory location is set to **1**, then press the setup **RECALL** button to initialize the 371B. If you have not saved the initial setup in memory, refer to “Saving the Initial (Default) Setup” on page 3-18.

5. Set the 371B controls as follows:
 - a. Set the **VERTICAL CURRENT/DIV** and **HORIZONTAL VOLTS/DIV** to appropriate values depending on the forward current and forward voltage rating of the diode.
 - b. Disable the step generator by holding down the cursor **SHIFT** button and then pressing the **STEP MULTI .1X** button.
6. Set the collector supply **HIGH CURRENT** breaker to the **ENABLED** position.
7. Rotate the collector supply **VARIABLE** knob slowly clockwise.

The dot traces the forward characteristic of the diode.

8. Set the collector supply **VARIABLE** knob so that forward current flows through the diode, then press the measurement **SWEEP** button.

The collector supply voltage is increased from 0 % to the value set by the collector supply **VARIABLE** knob, resulting in a series of dots representing the forward characteristic of the diode as shown in Figure 3-5.

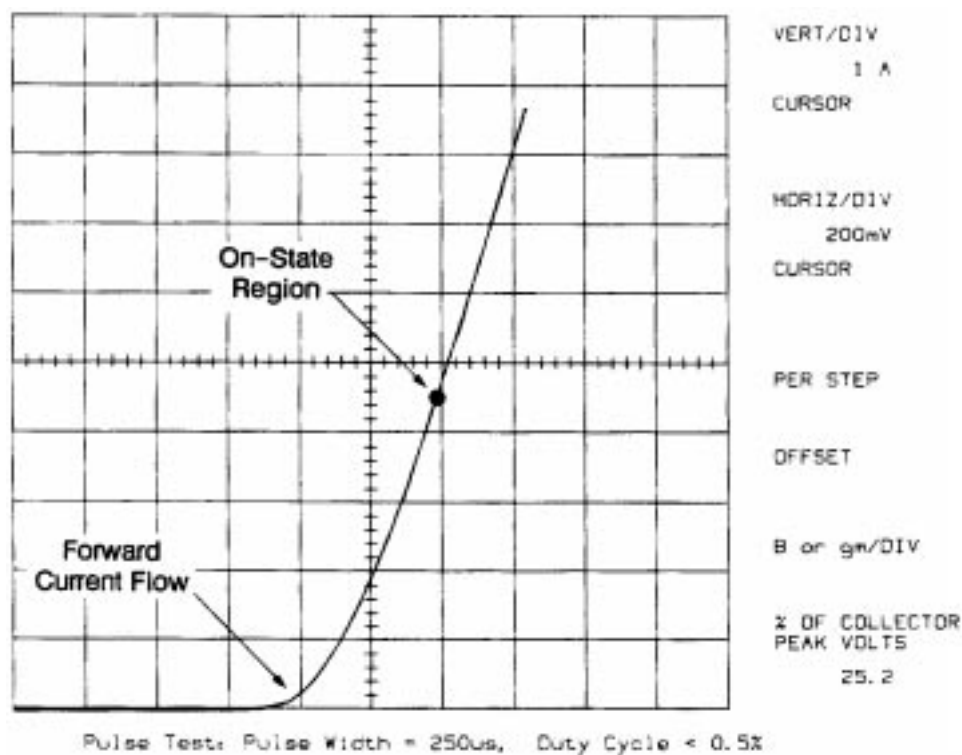

Figure 3-5: Sweep mode display of the forward characteristics of a diode

9. Select the dot cursor using the up cursor selection button.

Observe that a high-intensity dot is displayed on the origin of the characteristic curve. If the dot does not appear, adjust the **NON STORE/STORE/VIEW INTENSITY** control.

10. Move the dot cursor into the on-state region using the up, down, left, and right cursor position buttons.
11. Select the f line cursor with the up cursor button.

If the f line cursor does not appear, adjust the **READOUT/CURSOR INTENSITY** control.

12. Change the slope of the f line cursor using the up, down, left, right cursor position buttons until the cursor is tangent to the curve as shown in Figure 3-6.

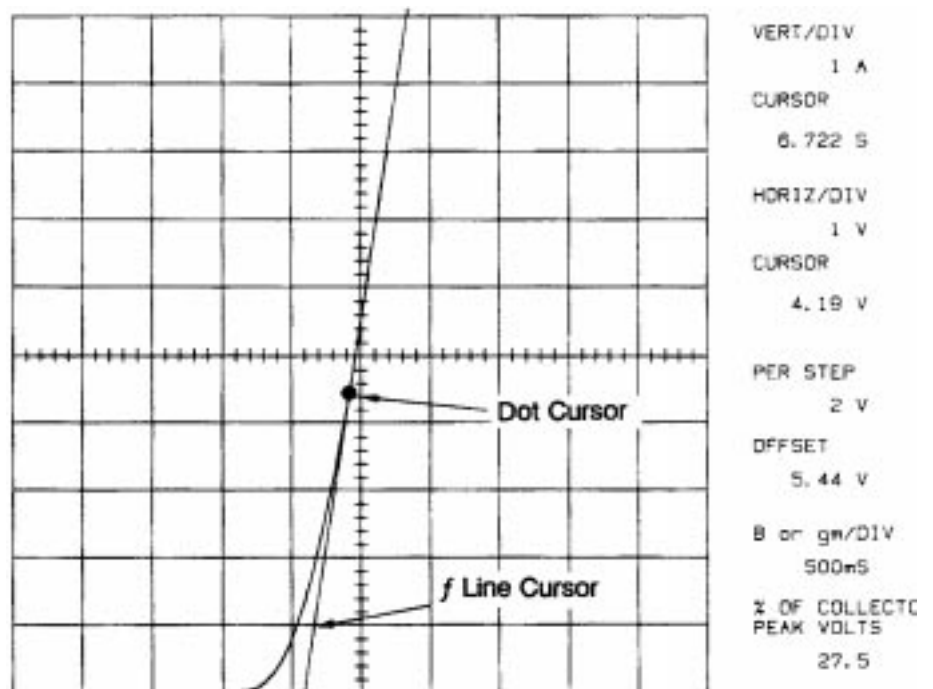

Figure 3-6: Using f line cursor to measure forward resistance of a diode

13. Observe that the CURSOR (f:1/grad) readout area indicates the on-state resistance of the diode.
14. Set the collector supply **HIGH CURRENT** breaker to the **DISABLED** position.

15. If you are continuing with the measurement examples, proceed with the next exercise “Measuring Breakdown Voltage Characteristics of a Diode.”

If you are finished testing at this point, open the protective cover, remove the diode, and power down the 371B.

Measuring Breakdown Voltage Characteristics of a Diode. The dot cursor is used in this demonstration.



CAUTION. *When using the A1005 test adapter, do not exceed its maximum voltage listed on the adapter. The plastic adapter can be damaged by excessive heat resulting from too high a voltage. If you expect this voltage to be exceeded, connect the DUT directly to the patch panel with patch cords as described in Step 4, below. For additional information refer to “Device Connection” on page 2–32.*

1. Set the collector supply **HIGH CURRENT** breaker to the **DISABLED** position and open the protective cover on the test fixture unit.
2. If using the A1005 test adapter, perform Step 3. If using patch cords with clips, perform Step 4.

NOTE. *For details about the adapter and patch panels, refer to the discussion under “Device Connection” on page 2–32.*

3. If using an A1005 test adapter, proceed as follows:
 - a. Insert the A1005 test adapter into the test adapter connector on the adapter panel.
 - b. Mount the diode in the test adapter with the anode lead to the C terminal at the top of adapter.
 - c. Connect the patch cords between connectors on the adapter and patch panels as shown in Figure 3–7.
 - d. Close the protective cover.

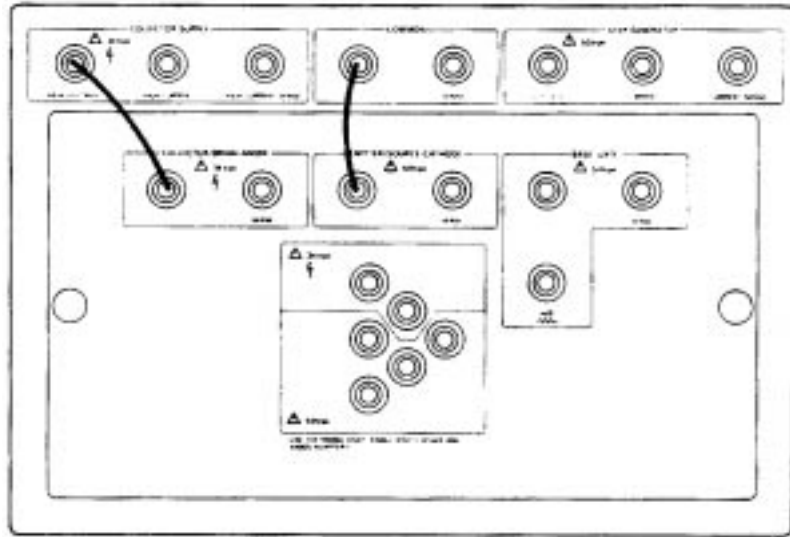

Figure 3-7: Adapter panel and patch panel connection for measuring diode breakdown voltage

4. If an A1005 test adapter is not available and you are using patch cords, perform the following:
 - a. Remove the adapter panel as described under “Device Connection” on page 2-32.
 - b. Using patch cords with alligator clips, connect the diode to the patch panel as follows:
 - Connect **COLLECTOR SUPPLY HIGH VOLTAGE** to the anode end of the diode.
 - Connect **COMMON** to the cathode end of the diode.
 - c. Close the protective cover on the test fixture unit.
5. Initialize the 371B by setting the memory location to **1** and then pressing the memory **RECALL** button. If you have not saved the initial setup in memory refer to “Saving the Initial (Default) Setup” on page 3-18.

Set the 371B controls as follows:

- a. Collector supply peak power watts to **3 W**.
- b. Collector supply **POLARITY** to **INVERT**.
- c. **VERTICAL CURRENT/DIV** and **HORIZONTAL VOLTS/DIV** to appropriate values for the reverse current and reverse breakdown voltage of the selected diode.

- d. Disable the step generator by holding down the cursor **SHIFT** button and then pressing the **STEP MULTI .1X** button.
- e. Press the display **INVERT** button (the INVERT LED lights).
6. Set the collector supply **HIGH VOLTAGE** breaker to the **ENABLED** position.
7. Rotate the collector supply **VARIABLE** knob slowly clockwise to trace the reverse characteristic curve of the diode.
8. If the display loops, adjust the **LOOPING COMPENSATION** control.
9. Rotate the collector supply **VARIABLE** knob farther clockwise to make breakdown current flow. You should see a display similar to the one shown in Figure 3–8.
10. Use the up cursor button to select the dot cursor, and use the up, down, left, and right cursor position buttons to move the cursor to the desired breakdown current level on the curve.

The vertical **CURSOR** (f: 1/grad) readout gives the current level and the horizontal **CURSOR** (f: 1/intercept) readout gives the breakdown voltage as shown in Figure 3–8.

11. Set the collector supply **HIGH VOLTAGE** to the **DISABLED** position.
12. Open the protective cover and remove the diode, test adapter (if used) and patch cords.

Reinstall the adapter panel, if removed. The 371B is now ready for another operation.

NOTE. For details about the adapter and patch panels, refer to “Device Connection” on page 2–32.

4. Use either the A1002 or A1003 test adapter, whichever is best suited for the type of transistor selected. Proceed as follows:
 - a. Mount the transistor in the test adapter.
 - b. Insert the test adapter into the test adapter connector on the adapter panel.
 - c. Connect patch cords between adapter and patch panels as shown in Figure 3–9.
 - d. Close the protective cover.
5. If using patch cords, perform the following:
 - a. Remove the adapter panel as described under “Device Connection” on page 2–32.
 - b. Using patch cords with alligator clips, connect the transistor to the patch panel connectors as follows:
 - Using two red patch cords, connect one cord to the **COLLECTOR SUPPLY HIGH CURRENT** connector, and the other cord to the **COLLECTOR SUPPLY HIGH CURRENT SENSE** connector.
 - Connect the alligator ends of both red patch cords to the collector lead of the transistor.
 - Using two black patch cords, connect one cord to the **COMMON** connector and the other cord to the **COMMON SENSE** connector.
 - Connect the alligator ends of both black patch cords to the emitter lead of the transistor.
 - Using two black patch cords, connect one cord to the **STEP GENERATOR CURRENT** connector and the other cord to the **STEP GENERATOR CURRENT SENSE** connector.
 - Connect the alligator ends of both black patch cords to the base lead of the transistor.
 - c. Close the protective cover on the test fixture unit. Check the location of the transistor leads to ensure that no short circuits exist to other leads or the inside of the test fixture unit.

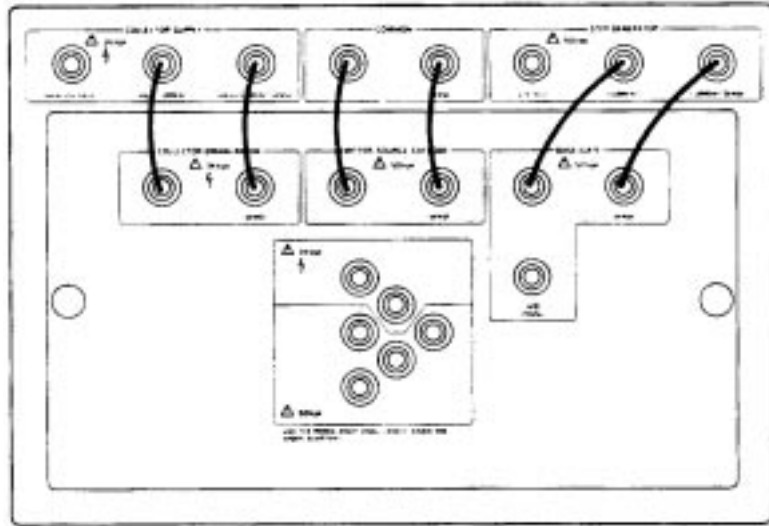

Figure 3-9: Adapter panel and patch panel connections for measuring bipolar transistor characteristics

6. Set the memory location to **1** then press the setup **RECALL** button to initialize the 371B. If you have not saved the initial setup in memory, refer to “Saving the Initial (Default) Setup” on page 3-18.
7. Set the 371B controls as follows:
 - a. Collector supply polarity to **NPN+** or **PNP-** depending on the type of transistor used.
 - b. **VERTICAL CURRENT/DIV** to about 1/10 of the rated collector (pulse) current.
 - c. Step generator **NUMBER OF STEPS** to **5**.
8. Set the collector supply **HIGH CURRENT** breaker to the **ENABLED** position.
9. Rotate the collector supply **VARIABLE** knob slowly clockwise until the lowest dot intercepts the horizontal axis at about ten divisions.
10. Press the **NUMBER OF STEPS** up button four times.
11. Observe that the number of dots displayed increases each time the button is pressed.
12. Rotate the **STEP/OFFSET AMPLITUDE** knob until the dots are separated by about one division.

13. Press the **STEP MULTI .1X** button and observe that the collector current decreases as the step amplitude is reduced to one-tenth of its previous setting.
14. Press the **STEP MULTI .1X** button again to resume normal operation.
15. Press the measurement **SWEEP** button.

In a few seconds, the collector current versus collector/emitter voltage characteristic curve will be displayed similar to the curve shown in Figure 3-10.

16. If you are continuing with the transistor measurement examples, proceed with the next exercise "Comparing an Acquired Curve With A Reference Curve".

If you are finished testing at this point, open the protective cover, and remove the transistor and patch cords. Reinstall the adapter panel, if removed.

The 371B is now ready for another operation.

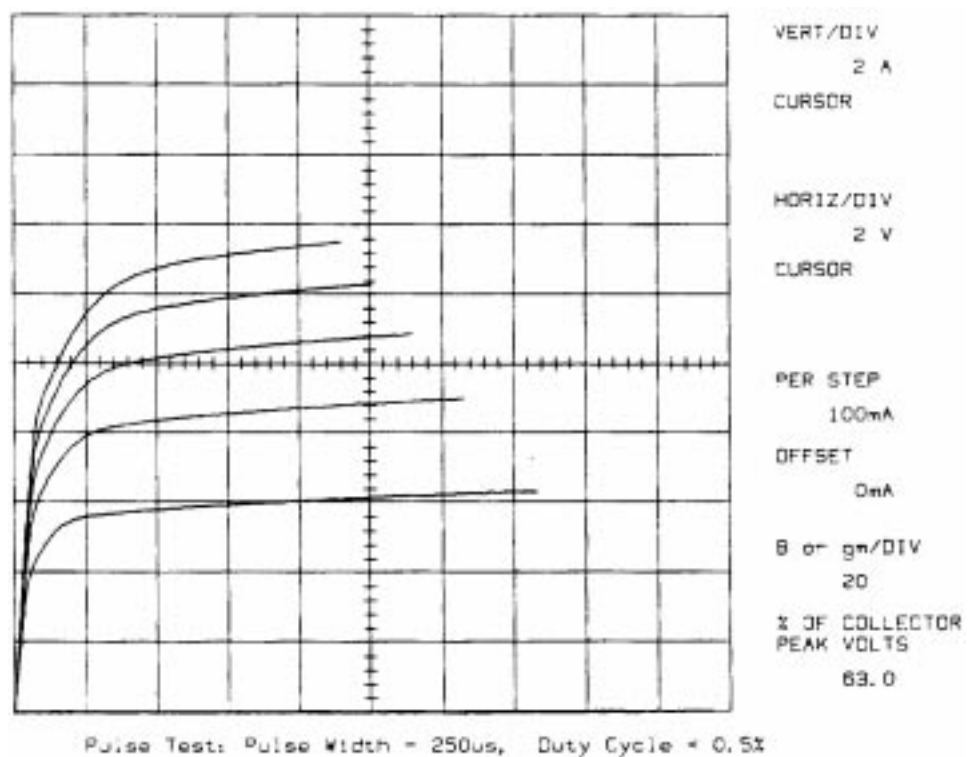

Figure 3-10: Collector current versus collector/emitter voltage characteristic curve

Comparing an Acquired Curve With a Reference Curve. This procedure demonstrates how to compare an acquired curve with a reference curve.

1. Acquire a characteristic curve by performing all steps of the preceding exercise “Displaying Collector Current Versus Collector/Emitter Voltage”.
2. Change the memory location to **2**, then press the display **ENTER** button.

Observe that message ENTER COMPLETE is displayed on the screen in the message area.

The characteristic curve on the screen is now stored in memory location 2. Press the display **VIEW** button to display the stored curve at any time.

3. Press the display **STORE** button again, then press the measurement **SWEEP** button.
4. The 371B displays the collector current versus collector/emitter voltage curve as shown earlier in Figure 3–10.
5. Turn the **REF INTENSITY** control throughout its range. Observe that only the brightness of the reference curve is varied.
6. Press the display **INVERT** button and the **REF** button again to resume normal operation.
7. Press the measurement **SWEEP** button again to display the characteristic curve of collector current versus collector/emitter voltage.
8. If you are continuing with the transistor measurement examples, proceed with the next exercise “Measuring Gain of a Bipolar Transistor”.

If you are finished testing at this point, open the protective cover, and remove the transistor and patch cords. Reinstall the adapter panel, if removed.

The 371B is now ready for another operation.

Measuring Gain of a Bipolar Transistor. To measure the gain of a bipolar transistor, perform the following steps.

1. Acquire a characteristic curve by performing all steps of the preceding exercise “Displaying Collector Current Versus Collector/Emitter Voltage”.
2. Position the window cursor as follows:
 - a. Use the cursor select up button to select the window cursor with the bottom left intensity dot.
 - b. Use the cursor position up, down, left, and right buttons to position the intensity dot, at any point on the characteristic curve.
 - c. Use the cursor select up button to select the window cursor with the top right intensity dot.
 - d. Press the cursor left position button to narrow the cursor window into a straight vertical line as shown in Figure 3–11.
 - e. Use the up or down cursor position buttons to position the bright dot of the window cursor on an adjacent characteristic curve as shown in Figure 3–11.

The number now display in the β or gm/div readout area is the h_{fe} (gain) of the DUT.

3. Set the collector supply **HIGH CURRENT** breaker to the **DISABLED** position.
4. If you are continuing with the transistor measurement examples, proceed with the next exercise “Measuring Saturation Voltage”.

If you are finished testing at this point, open the protective cover, and remove the transistor and patch cords. Reinstall the adapter panel, if removed.

The 371B is now ready for another operation.

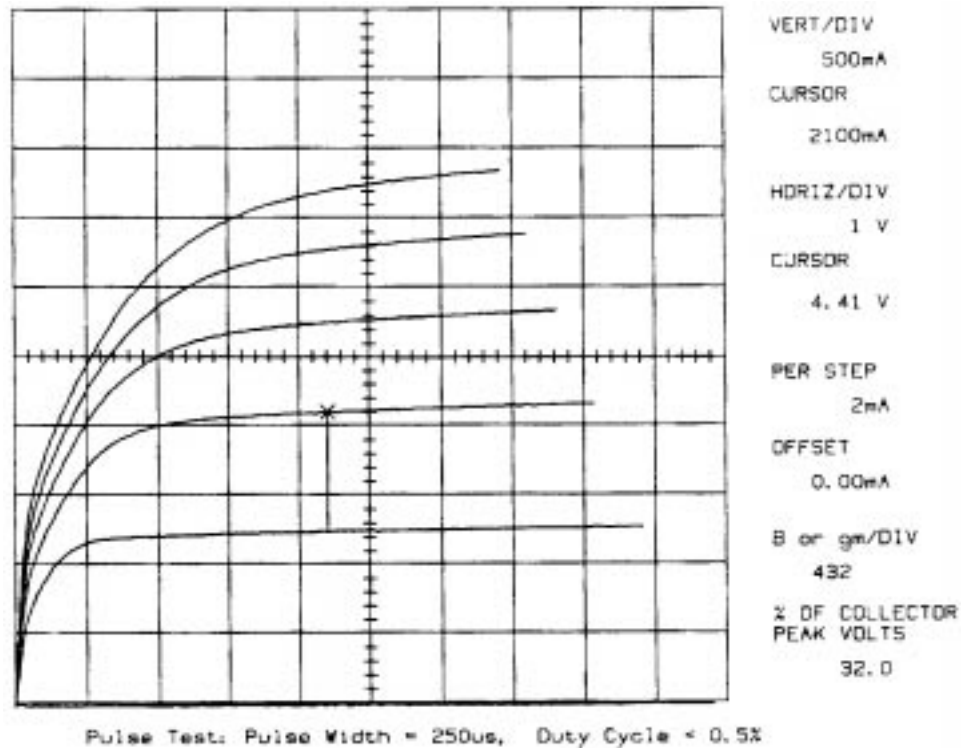

Figure 3-11: Using the window cursor to calculate hfe of a bipolar transistor

Measuring Saturation Voltage. This procedure demonstrates how to measure the saturation voltage of an NPN bipolar transistor at 10 A I_C and 2 A I_B .

1. Obtain a high-power bipolar transistor. (For the following procedures we used an NPN bipolar transistor with a BV_{CEO} rating of 1500 V.)
2. Install the transistor as described in Steps 3 – 5 of the preceding exercise, “Displaying Collector Current Versus Collector/Emitter Voltage”.
3. Set the memory location to **1**, then press the setup **RECALL** button to initialize the 371B. If you have not saved the initial setup in memory, refer to “Saving the Initial (Default) Setup” on page 3-18.

4. Set the 371B controls as follows:

Step Generator

NUMBER OF STEPS 0

STEP/OFFSET AMPLITUDE 500 mA/Step

Display

VERTICAL CURRENT/DIV 2 A

HORIZONTAL VOLTS/DIV 100 mV COLLECTOR

5. Close the protective cover, then set the collector supply **HIGH CURRENT** breaker to the **ENABLED** position.
6. Set the **OFFSET** readout (I_B) to **2000 mA** using the step generator up and down **OFFSET** buttons.
7. Increase the collector supply **VARIABLE** setting until the dot rises above the 10 A graticule line, which is the center horizontal graticule line.
8. Press the measurement **SWEEP** button to display a curve similar to the curve shown in Figure 3–12.
9. Use the cursor selection up and down buttons to select the dot cursor.
10. Use the cursor position up, down, left, and right buttons to move the dot cursor to the 10 A level on the curve.
11. Read the V_{CE} (saturation) value in the **HORIZ/DIV CURSOR** readout area.
12. Set the collector supply **HIGH CURRENT** breaker to the **DISABLED** position.

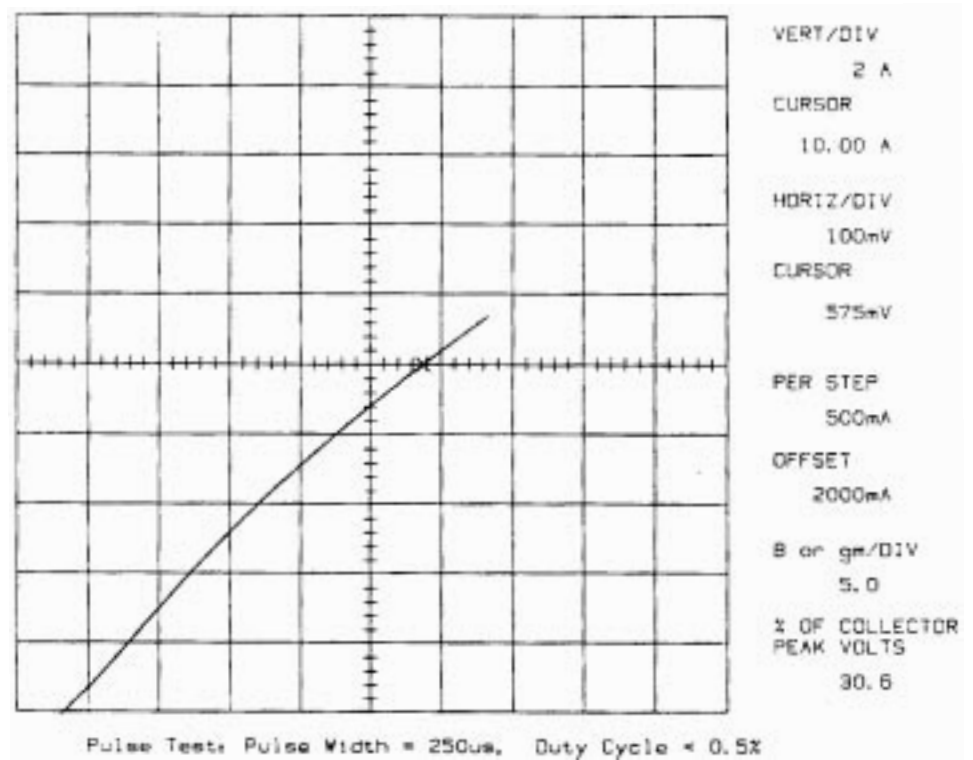

Figure 3-12: V_{CE} (saturation) curve for a bipolar transistor

13. If you are continuing with transistor measurement examples, proceed with the next exercise, “Measuring Breakdown Voltage”.

If you are finished testing at this point, open the protective cover, and remove the transistor and patch cords. Reinstall the adapter panel if removed.

The 371B is now ready for another operation.

Measuring Breakdown Voltage. This procedure demonstrates how to measure the collector/emitter breakdown voltage of a bipolar transistor.

1. Obtain a high-power bipolar transistor, (For the following procedures we used an NPN bipolar transistor with a BV_{CEO} rating of 1500 V.)
2. Set the collector supply **HIGH VOLTAGE** and **HIGH CURRENT** breakers to the **DISABLED** position and open the protective cover on the test fixture unit.
3. If using a test adapter, perform Step 4. If using patch cords, perform Step 5.

NOTE. For details about the adapter and patch panels, refer to the discussions under “Device Connection” on page 2–32.

4. Use either the A1002 or A1003 test adapter, whichever is best suitable for the type of transistor selected. Proceed as follows:
 - a. Mount the transistor in the test adapter.
 - b. Insert the test adapter into the test adapter connector on the adapter panel.
 - c. Connect the patch cords between connectors on the adapter and patch panels as illustrated in Figure 3–13.
 - d. Close the protective cover.

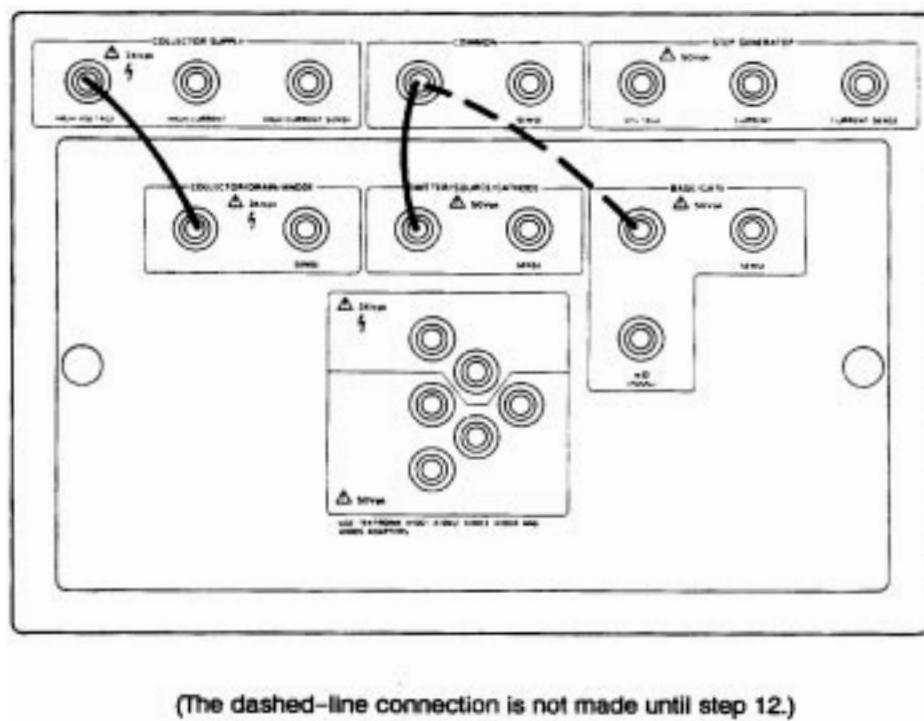

Figure 3–13: Adapter panel and patch panel connections for measuring breakdown voltage characteristics of a bipolar transistor

5. If using patch cords, perform the following:
 - a. Remove the adapter panel as described under “Device Connection” on page 2–32.

13. Close the protective cover.
14. Set the collector supply **HIGH VOLTAGE** breaker to **ENABLED**.
15. Slowly increase the collector supply **VARIABLE** until breakdown occurs.
16. Use the cursor select buttons to select the dot cursor.
17. Use the cursor position buttons to move the dot cursor into the breakdown region.
18. The breakdown voltage (BV_{CES}) is displayed in the horizontal CURSOR (f: 1/intercept) readout area on the CRT display.
19. Observe that the stored BV_{CEO} curve in the reference memory and the BV_{CES} curve in store mode are displayed on the CRT, as shown in Figure 3-14.

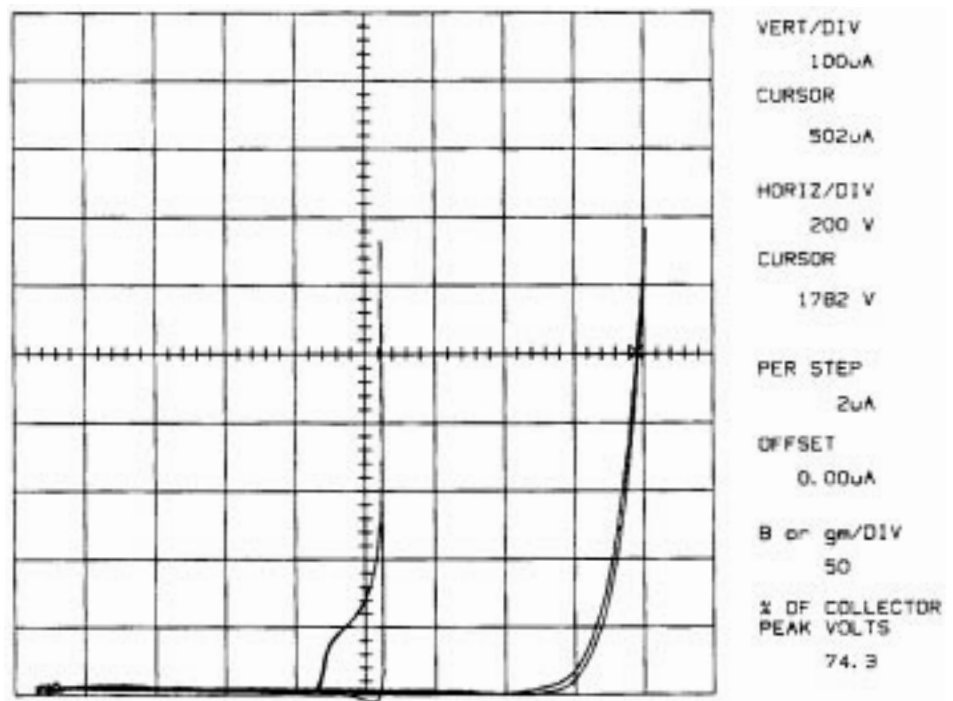

Figure 3-14: Display of the BV_{CEO} and BV_{CES} breakdown measurements with reference function

20. Set the collector supply **HIGH VOLTAGE** breaker to the **DISABLED** position.
21. This completes the transistor measurement exercises.

Open the protective cover and remove the transistor and patch cords.
Reinstall the adapter panel if removed.

The 371B is now ready for other test applications.

Power MOSFET Measurement Exercises

The techniques for measuring the operating characteristics of power MOSFET are similar to the techniques used for bipolar transistors. Table 3–3 compares the equivalent characteristics between the two semiconductor devices.

Table 3–3: Bipolar Transistor/MOSFET Characteristics Comparison

Bipolar Transistor	MOSFET
Collector	Drain
Emitter	Source
Base	Gate
$V_{(BR)CES}$	$V_{(BR)DSS}$
V_{CBO}	V_{DGR}
I_C	I_D
I_{CES}	I_{DSS}
I_{EBO}	I_{GSS}
$V_{BE(ON)}$	$V_{GS(th)}$
$C_{VE(SAT)}$	$V_{DS(on)}$
C_{ib}	C_{iss}
C_{ob}	C_{oss}
h_{fe}	g_{fs}
$R_{ce(sat)} = \frac{V_{CE(sat)}}{I_C}$	$r_{ds(on)} = \frac{V_{DS(on)}}{I_D}$
V_{EC}	V_{SD}

These procedures demonstrate how to

- Display drain current versus drain/source voltage characteristics.
- Measure forward admittance.

Displaying Drain Current versus Drain/Source Voltage Characteristics. This procedure demonstrates how to display drain current versus drain/source voltage of a MOSFET.

1. Obtain an N-channel enhancement-type power MOSFET.
2. Set the collector supply **HIGH VOLTAGE** and **HIGH CURRENT** breakers to their **DISABLED** position and open the protective cover on the test fixture unit.
3. If using a test adapter, perform Step 4. If using patch cords, perform Step 5.

NOTE. For details about the adapter and patch panels, refer to the discussion under “Device Connection” on page 2–32.

4. Use either the A1002 or A1003 test adapter (standard accessories), whichever is best suitable for the type of MOSFET selected. Proceed as follows:
 - a. Mount the MOSFET in the test adapter.
 - b. Insert the test adapter into the test adapter connector on the adapter panel.
 - c. Connect the patch cords between connectors on the adapter and patch panels as shown in Figure 3–15.
 - d. Close the protective cover.

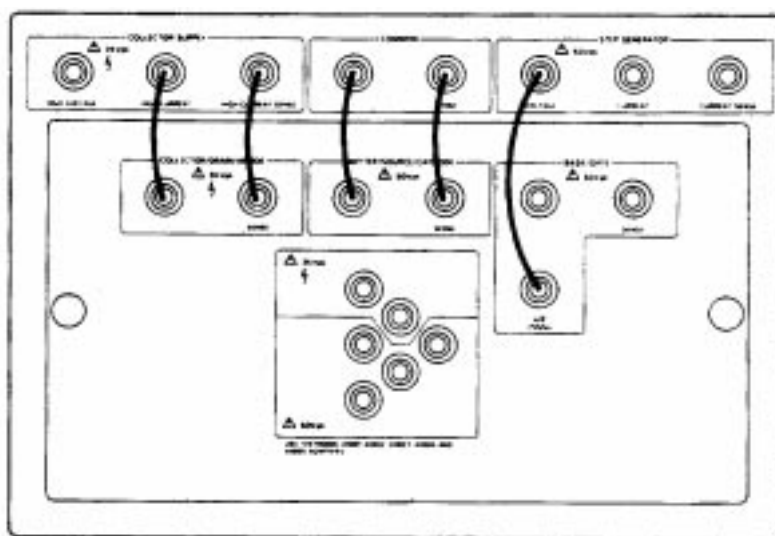

Figure 3–15: Adapter panel and patch panel connections for measuring power MOSFET characteristics

NOTE. *Kelvin sensing is used in this measurement example because of the high current levels flowing through the DUT. Thus sensing is done through the 1 k Ω resistor inside the adapter panel. This helps to prevent oscillations.*

5. If using patch cords, perform the following:
 - a. Remove the adapter panel as described under “Device Connection” on page 2–32.
 - b. Using patch cords with alligator clips, connect the MOSFET to the patch panel connectors as follows:
 - Using two red patch cords, connect one cord to the **COLLECTOR SUPPLY HIGH CURRENT** connector, and the other cord to the **COLLECTOR SUPPLY HIGH CURRENT SENSE** connector.
 - Connect the alligator ends of both red patch cords to the drain lead of the MOSFET.
 - Using two black patch cords, connect one cord to the **COMMON** connector and the other cord to the **COMMON SENSE** connector.
 - Connect the alligator ends of both black patch cords to the source lead of the MOSFET.
 - Connect an alligator patch cord to the **STEP GENERATOR VOLTAGE** connector and the other end to the gate lead of the MOSFET.
 - Connect the alligator end of the black patch cord to the base lead of the transistor.

NOTE. *It may be necessary for you to add a 1 k Ω resistor in series with the base lead to stabilize the device.*

- c. Close the protective cover on the test fixture unit. Check the location of the transistor leads to ensure that no short circuits exist to other leads or to the inside of the test fixture unit.

NOTE. *Kelvin sensing is used in this measurement example because of the high current levels flowing through the DUT. The 1 k Ω resistor in series with the **STEP GENERATOR VOLTAGE** connector helps prevent oscillation.*

6. Set the memory location to **1**, then press the setup **RECALL** button to initialize the 371B. If you have not saved the initial setup in memory, refer back to “Saving the Initial (Default) Setup” on page 3–18.

7. Set other 371B controls as follows:
 - a. Collector supply **PEAK POWER WATTS** to **3 kW** or **300 W** depending on the MOSFET power rating.
 - b. Set the 371B controls as follows:
 - SOURCE VOLTAGE
 - NUMBER OF STEPS 0
 - STEP MULTI.1X ON
 - STEP/OFFSET AMPLITUDE 500 mV (with STEP MULTI.1X on)
 - c. **VERTICAL CURRENT/DIV** to about 1/10 of the rated drain (pulse current).
 - d. **HORIZONTAL VOLTS/DIV** to 2 V COLLECTOR.
8. Use the cursor select up button to select the dot cursor.
9. Set the collector supply **HIGH CURRENT** breaker to the **ENABLED** position.
10. Rotate the collector supply **VARIABLE** knob slowly clockwise and move the displayed dot about ten division to the right.
11. Press the **OFFSET** up button until there is a change in the vertical **CURSOR** (f: 1/grad) readout, indicating the onset of drain current flow.
12. Press the **NUMBER OF STEPS** up button five times.
13. Observe that the number of dots displayed increases each time the button is pressed.
14. Press the measurement **SWEEP** button.

In about 15 seconds, drain current versus drain-source voltage characteristic curves will be displayed similar to those shown in Figures 3–16 and 3–17.
15. Set the collector supply **HIGH CURRENT** breaker to the **DISABLED** position.
16. If you are continuing with MOSFET measurement examples, proceed with the next exercise “Measuring Forward Admittance of a Power MOSFET.”

If you are finished testing at this point, open the protective cover, and remove the MOSFET and patch cords. Reinstall the adapter panel if removed.

The 371B is now ready for another operation.

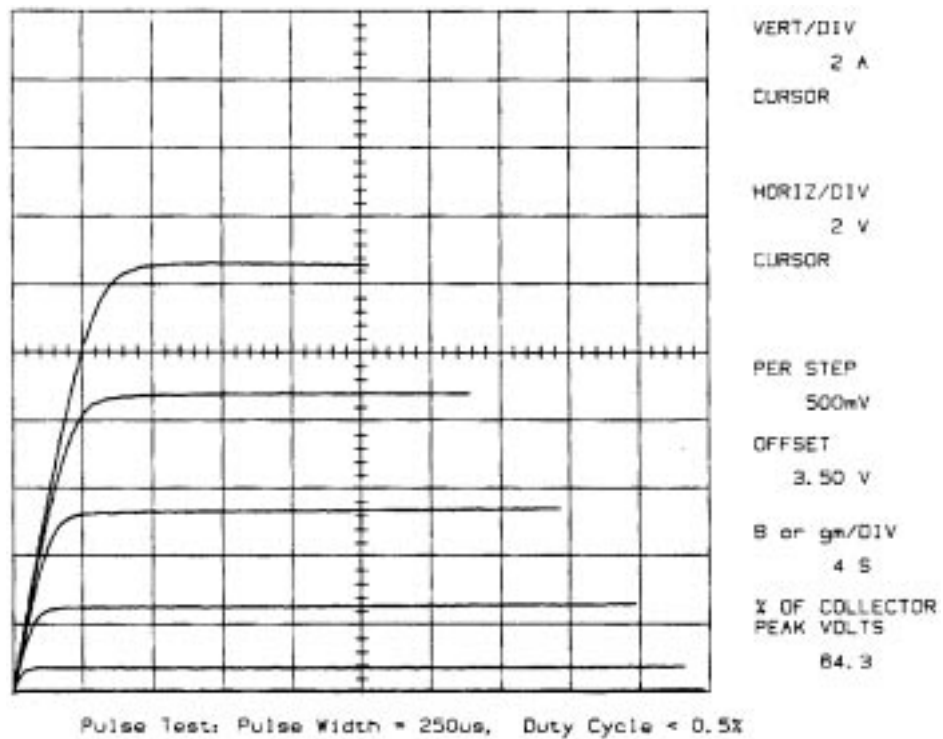

Figure 3-16: Drain current versus drain/source voltage characteristics for a power MOSFET

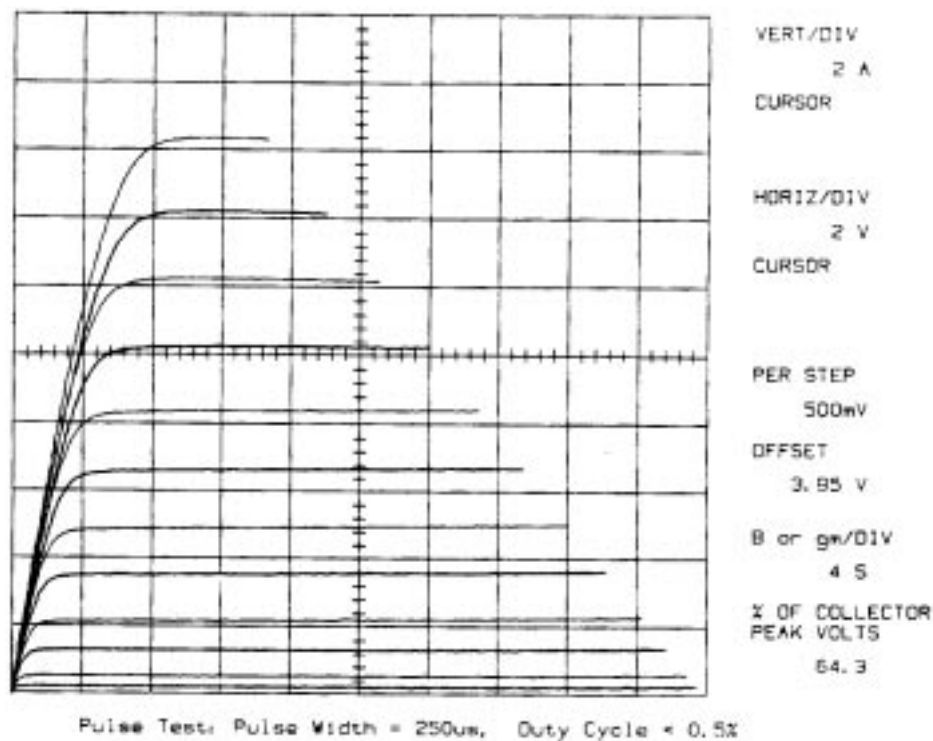

Figure 3-17: Drain current versus drain/source voltage characteristics for 10 steps with the reference display

Measuring Forward Admittance of a Power MOSFET. This procedure demonstrates how to measure forward admittance of a power MOSFET using the f line cursor.

1. Install an N-channel enhancement-type power MOSFET as described in Steps 2 through 5 of the preceding exercise “Displaying Drain Current versus Drain/Source Voltage Characteristics”.
2. Set the memory location to **1**, then press the setup **RECALL** button to initialize the 371B. If you have not saved the initial setup in memory, refer back to “Saving the Initial (Default) Setup” earlier in this chapter.
3. Set other 371B controls as follows:
 - a. Collector supply peak power watts to **3 kW** or **300 W** depending on the MOSFET power rating.
 - b. Set the 371B controls as follows:

SOURCE VOLTAGE

NUMBER OF STEPS 0

STEP/OFFSET AMPLITUDE 2 V

- c. VERTICAL CURRENT/DIV to about 1/10 of the rated drain (pulse current).
4. Set the collector supply **HIGH CURRENT** breaker to the **ENABLED** position.
5. Select the dot cursor with the cursor select buttons.
6. Rotate the collector supply **VARIABLE** knob clockwise to move the displayed dot about five divisions to the right.
7. Set the **HORIZONTAL VOLTS/DIV** control to the **STEP GEN (V_{BE}) 1 V** position.
8. Press the **OFFSET** up button to increase the gate/source voltage until desired vertical deflection is obtained.
9. Press the measurement **SWEEP** button.

The offset signal automatically sweeps to trace the drain current versus gate-voltage characteristic curve similar to the curve shown in Figure 3–18.

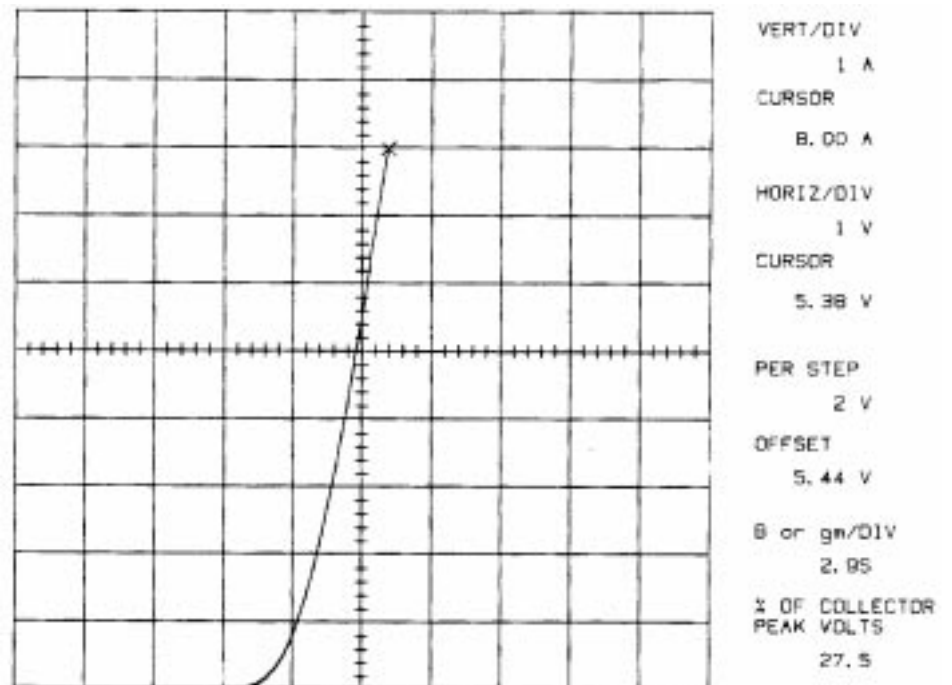

Figure 3–18: Forward transfer curve, $I_D = 8 A$

10. Use the cursor position buttons to move the dot cursor until the drain current readout attains the forward transfer admittance measurement condition value.

11. Use the cursor select up button to select the f line cursor.
12. Use the cursor position buttons to adjust the slope of the f line cursor until it is tangent to the curve as shown in Figure 3-19.

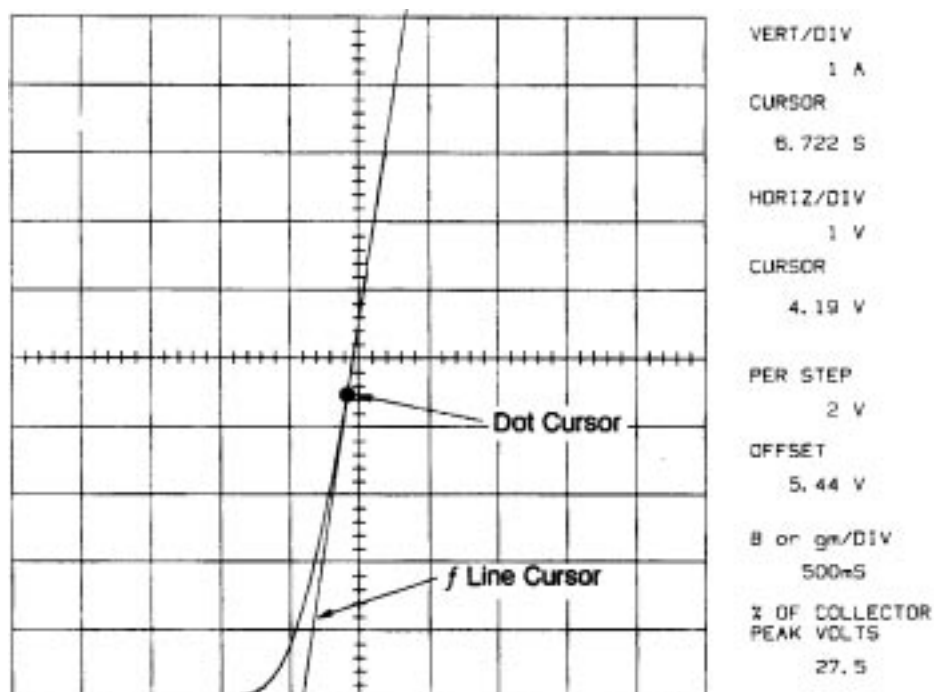

Figure 3-19: Using the f line cursor to measure forward transfer admittance of a power MOSFET. In this example, $G_{fs} = 6.722 \text{ S}$

13. The CURSOR (f:1/grad) readout area indicates the forward transfer admittance.
14. Set the collector supply **HIGH CURRENT** breaker to the **DISABLED** position.
15. If you are finished testing at this point, open the protective cover, and remove the MOSFET and patch cords. Reinstall the adapter panel if removed.

The 371B is now available for another operation.



GPIB

GPIB

This chapter describes the GPIB Interface used by the 371B following order:

- Review of GPIB principles.
- Interface capabilities.
- System setup and configuration.
- Controlling the 371B over the GPIB.
- Device-dependent message format.
- Front-panel settings and corresponding GPIB commands.
- Command reference (command descriptions).
- Service requests.

Review

The General Purpose Interface Bus, or GPIB, is a standardized, digital interface for interconnecting up to 15 self-contained instruments, controllers, and other devices. The instruments may be units such as the 371B High Power Curve Tracer, signal generators, digital multimeters, or digital oscilloscopes. The ANSI (American National Standards Institute) and IEEE (Institute of Electric and Electronic Engineers, Inc.) standards define two aspects of the interface: the hardware and a basic communication protocol.

Hardware

The hardware consists of a set of interface circuits in each device, along with standard 24-conductor cabling for interconnecting the devices in a system. Sixteen of the 24 wires are used for signaling: eight for addresses or data, three for handshaking during data transfers, and five for interface management. Most data is transferred as a series of eight-bit bytes over the eight data lines.

Communication Protocol

The basic communication protocol specifies a set of pre-defined interface messages for system organization and housekeeping, but only indicates the basic requirements for communicating other information such as setup commands and measurement results. The protocol does not define the meaning or format of the measurement results, which are termed device-dependent messages.

Meaningful messages for each instrument are specified by the instrument manufacturer and are usually defined in the instrument manual. Tektronix has standardized on a higher level protocol for all its GPIB instruments, called Tektronix Codes and Formats.

A typical GPIB system will include a controller and one or more instruments, such as the 371B. Some instruments are talk-only or listen-only devices while others can both talk and listen. The 371B does both. Linking a controller to the 371B, and possibly other instruments, provides operation in four major task areas:

- Program development
- System control
- Data processing
- Display and storage

These four tasks are discussed in the following paragraphs.

Program Development. Program development includes writing, editing, and debugging the programs needed to control the instruments in the system.

System Control. While running a program, the controller assigns tasks to instruments in the system, coordinates communication, handles error conditions, and monitors the system's progress.

This instrument control task can be further divided into six functions:

- Addressing instruments.
- Sending commands.
- Transmitting and receiving data.
- Handling interrupts.
- Data processing.
- Display and storage.

Each of these system control functions are explained below.

Addressing Instruments. The controller selects an instrument by addressing it. Each instrument on a bus is assigned a unique primary address in the range 0 through 39. The controller uses this address to set an instrument to talk or listen.

Sending Data and Commands. Device-dependent messages carry commands and data from the controller to the 371B and return instrument status information and measurement data. The ATN line (pin 11 of the GPIB) is asserted while interface messages are sent to identify them from device-dependent messages. (See Figure 4-1 for a graphic representation of this interaction.)

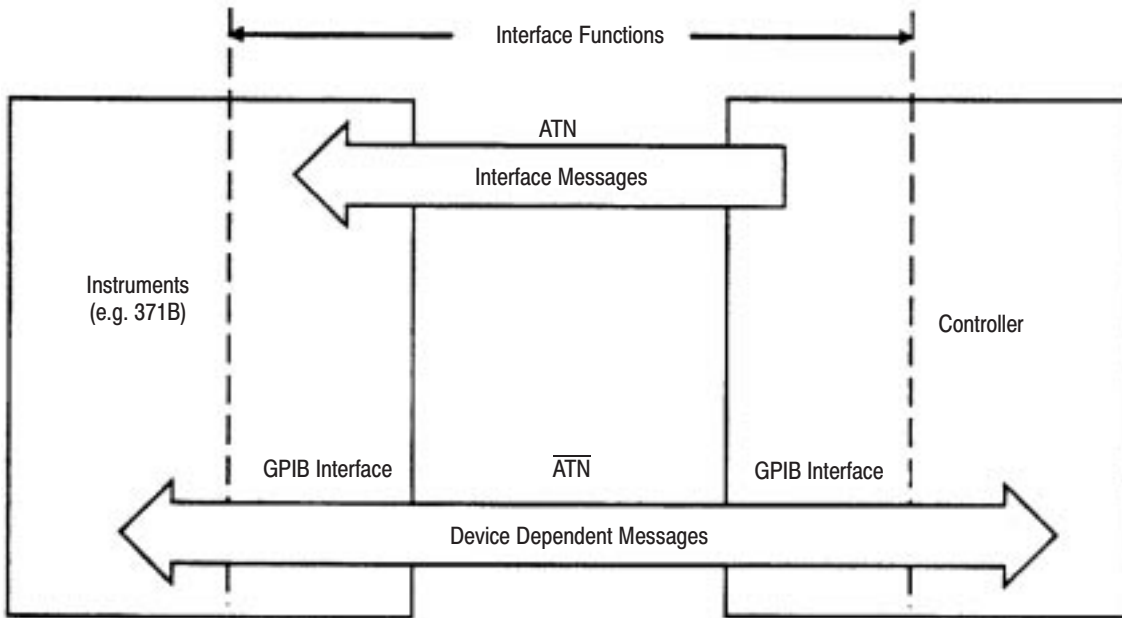

Figure 4-1: GPIB messages

Interface messages are commands that control interface functions. The IEEE Standard 488 specifies interface messages so that they are the same for all devices.

There are two kinds of interface messages: uni-line and multi-line, where “line” refers to the 16 signal lines within the bus. Multi-line messages can be further subdivided into universal commands, addresses, and addressed commands. Figure 4-2 shows how the different types of GPIB messages are related and indicates the standard three-letter symbols assigned to them.

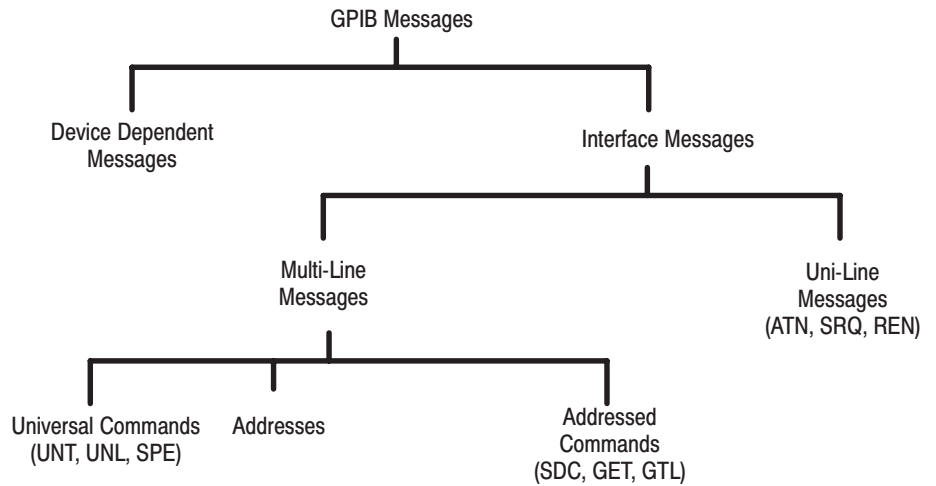

Figure 4-2: GPIB message types

Multi-line interface messages are sent by placing a byte on the eight data lines of the GPIB and asserting the ATN line. Universal commands affect all devices on the bus while addresses and addressed commands affect only the addressed instruments.

Uni-line interface messages are sent by asserting one of the five individual interface signal lines of the GPIB:

- SRQ (service request)
- ATN (attention)
- IFC (interface clear)
- REN (remote enable)
- END (EOI, end or identify)

Device-dependent messages consist of commands or data that control instrument function and communicate instrument status, as well as data from measurements and other information. As noted before, the content and format of these messages has been addressed with Tektronix Codes and Formats. All of these message types are significant for the 371B.

Transmitting and Receiving Data. Most instruments talk (send data) and listen (receive data) to the system controller. The 371B does both. In fact, the 371B sends and receives two classes of data: instrument setups and measurement results. There are various ways of coding such data. The 371B, in keeping with Tektronix Codes and Formats, uses English keywords for setup and status data and a combination of similar keywords and a form of binary-coded numbers for measurement data.

Handling Interrupts. The 371B and other devices in the system can generate interrupts to inform the controller of conditions warranting some sort of attention, such as an error condition or the completion of an operation. The controller polls the devices on the bus to find the source of the interrupt, reads its status, and takes appropriate action.

Data Processing. Still another major task of a GPIB system is processing the data acquired from instruments. Examples of this processing are extracting key parameters from a family of curves and deciding whether some pass-fail criterion has been exceeded.

Display and Storage. Once data has been sent to the controller it can be stored or displayed, as well as processed. The controller console screen is one place data may be displayed.

Interface Capabilities

IEEE Standard 488 defines a variety of possible interface capabilities for differing needs among various controllers and instruments.

Table 4–1 summarizes the capabilities realized in the 371B. The abbreviations are detailed in the IEEE standard.

Table 4–1: GPIB Interface Specifications

Function	Subset	Note
Source Handshake	SH1	Complete Capability
Acceptor Handshake	AH1	Complete Capability
Talker	T6	Basic Talker, Serial Poll, Talk Only, Unaddress if MLA
Listener	L4	Basic Listener, Unaddress if MTA
Service Request	SR1	Complete Capability
Remote / Local	RL2	Complete Capability
Parallel Poll	PP0	Not Capability
Device Clear	DC1	Complete Capability
Device Trigger	DT0	Not Capability
Controller	C0	Not Capability

Interface Messages

The following explains how the curve tracer reacts to standard interface messages. Abbreviations are from IEEE Standard 488, As noted before, a uni-line message is sent over a dedicated line and a multi-line message is sent using the eight data lines while the ATN line is asserted. In the following descriptions, uni-line messages are described as having the appropriate line asserted. Multi-line messages are described with their respective ASCII code and decimal value for the eight-bit byte expressed on the eight data lines.

Due to the set of interface functions required for the 371B, not all of the possible interface messages would be meaningful. The 371B does not respond to the following:

- GET Group execute trigger
- PPC Parallel poll configure
- PPU Parallel poll unconfigure
- TCT Take control

It does respond to or use the following interface messages, as described.

My Listen and My Talk Address (MLA and MTA). The 371B's address is established by setting the address select switches on the rear panel. When the 371B receives its own address along with either of these commands, it responds by entering the appropriate state: ready to talk or ready to listen.

Attention (ATN). With the ATN line asserted, data on the eight data lines is interpreted as an address or interface message. With most controller programming languages, operation of the ATN line is transparent to the user.

Unlisten (UNL) and Untalk (UNT). When the Unlisten (UNL) message (ASCII "?", decimal 63) is received, the 371B listen function is placed in an idle (unaddressed) state. In the idle state, the 371B will not accept messages over the GPIB. The Talk function is placed in an idle state when the curve tracer receives the Untalk(UNT) message (ASCII "_", decimal 95). In this state the 371B cannot transmit data via the GPIB.

Interface Clear (IFC). When the interface clear (IFC) line is asserted, both the Talk and Listen functions are placed in an idle state. This produces the same effect as receiving both the Untalk and Unlisten commands. It resets the interface only, clearing the input and output buffer, and does not affect any instrument functions. This can be used to restart communication with the 371B.

Device Clear (DCL). The Device clear (DCL) message (ASCII "Control T", decimal 20) reinitializes communication between the 371B and the controller. In response to Device Clear, the 371B clears any input and output messages as well as any unexecuted control settings. Any errors and events waiting to be reported, except power-up, are also cleared. If the SRQ line has been asserted for any reason other than power-up, it becomes unasserted when DCL is received.

Selected Device Clear (SDC). The Selected Device clear (SDC) message (ASCII "Control D", decimal 4) performs the same function as DCL. However, only instruments that have been listen-addressed respond to SDC.

Go To Local (GTL). The Go To Local (CTL) message (ASCII "Control A", decimal 1) returns the 371B to the front panel and turns off the front panel REMOTE indicator, just as the front panel LOCAL button does.

Remote Enable (REN). When the Remote Enable (REN) line is asserted and the instrument receives its listen address (MLA), the 371B is placed in its Remote State (REMS) and the front panel REMOTE indicator is turned on.

Service Request (SRQ). The Service Request (SRQ) line is set by the 371B each time it has a change in status to report to the controller.

Serial Poll Enable and Disable (SPE and SPD). The Serial Poll Enable (SPE) message (ASCII Control X, decimal 24) causes the 371B to transmit its serial-poll status byte when it is talk addressed. The Serial Poll Disable (SPD) message (ASCII Control Y, decimal 25) switches the 371B back to normal operation.

End or Identity (END or EOI). The 371B or controller sets End Or Identify (EOI) simultaneously with the last byte of the command or data if LF (line feed) /EOI is currently selected as the message terminator. If LF alone is selected, the message terminator is LF accompanied by EOI and followed by a CR (carriage return).

Local Lockout (LLO). When a Local Lockout (LLO) message (ASCII "Control 0", decimal 17) is received, the 371B enters the Lockout state.

NOTE. *The 371B has no front panel Lockout indicator to indicate when Lockout is set. Once set, all subsequent inputs from front panel keys with corresponding remote commands will be ignored.*

Device Dependent Messages

Device dependent messages for the 371B are in three categories: commands and queries, setup data, and measurement data.

Commands and Queries. Commands are sent to the 371B to initiate some action or change its settings. Some commands may be as short as three characters. Other more complex commands may be much longer.

A notable subcategory of commands is that of query commands or queries. The 371B responds to a query by sending another device dependent message back to the controller. This response communicates the appropriate instrument status, settings, or measurement data. These messages may also vary from a few characters to many characters in length.

Setup Data. Since most front panel settings are programmable, a series of commands can set-up the 371B for a particular measurement. In fact, a group of individual settings or an entire front panel setup can be strung together and sent as a single message.

Queries can be used, in turn, to send individual settings or complete front panel setups back to the controller. This means a setting can be made manually and then stored using the bus controller, providing an alternative to storing the setting in the mass storage of the 371B.

Measurement Data. Usually the most significant data available from the 371B are sets of characteristic curves from devices being tested. For any given measurement this data is packaged in two parts: a preamble and a curve. Preambles and curves can be read from the 371B into the controller either separately or combined. Later they can be loaded back into the 371B for further use.

The preamble contains the information needed for interpreting, scaling, and labeling the numeric information in the curve. This preamble is coded in ASCII characters and is readable by the operator without interpretation by the controller.

The curve is a series of binary-coded numbers expressing the X-Y coordinates of the 1024 digitized points representing the displayed curves. These binary-coded numbers are interpreted by the controller.

Two other types of data that can be read out of the 371B are: the coordinates of a cursor located on the curves, and the text shown in the text-display area of the screen.

Setup

The first steps in putting the 371B to work in a system are:

- Setting the bus address
- Choosing the message terminator
- Connecting the GPIB cable
- Powering up

These steps are discussed in the following paragraphs.

Setting the Bus Address

The 371B has a configuration switch bank on the rear panel which is used to set the bus address and message terminator (see Figure 4–3).

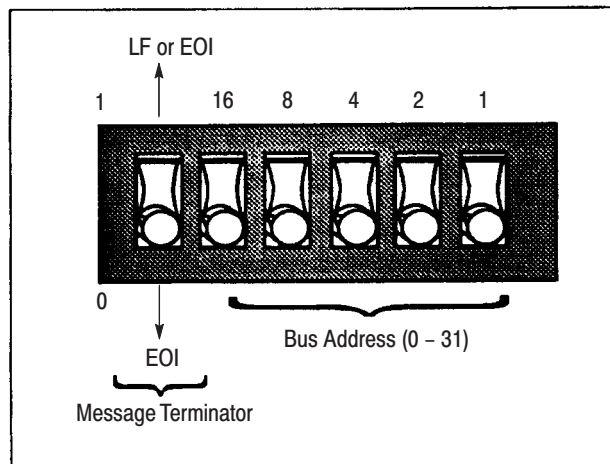

Figure 4–3: Rear panel configuration switch

Each instrument connected to the bus must have a unique address. This address is used by the controller to direct the flow of data to and from that specific device.

When choosing a bus address for the instrument, remember:

- The address of the 371B must be unique on the bus.
- Some controllers reserve an address for themselves.
- Selecting an address of 31 logically removes the 371B from the bus; it does not respond to any GPIB address, but remains both unlistened and untalked.
- The 371B uses primary addressing only. Sending a secondary address will have no effect.

- The address setting can be verified or changed by examining or setting the address switches located on the rear of the 371B (see Figure 4–3).

The address can also be verified by simultaneously pressing the front panel cursor SHIFT button and GPIB/ADDR keys. The message terminator and bus address appear in the error message area of the 371B.

Choosing the Message Terminator. The terminator is used to indicate the end of a message transfer. The two most common terminators are the EOI (end or identify) signal line and the LF (line feed) character.

If EOI is selected, the 371B will assert the EOI line simultaneously with the last data byte when sending a message, and will recognize the EOI line as the terminator when receiving a message. If LF is selected, a CR (carriage return) and LF (line feed) are sent following the last data byte, The EOI line is asserted simultaneously with the LF character.

When receiving a message, the 371B will terminate the message upon receiving either the LF character or the assertion of the EOI line.

The best way to determine which terminator to use is to look at the specifications for the system controller.

The terminator can be set with the terminator switch on the rear panel configuration switch bank (see Figure 4–3).

Reading in the Switch Settings. The switch settings are read by the 371B's processor only at power-up or when the message terminator and bus address are displayed on the CRT. Therefore, when switches are changed while the power is on, simultaneously press the cursor SHIFT and GPIB/ADDR keys to make the switch change effective.

Connecting the GPIB Cable

The 371B is attached to the GPIB using a standard GPIB cable. A GPIB system may be connected in two general configurations; a star or line as shown in Figure 4-4.

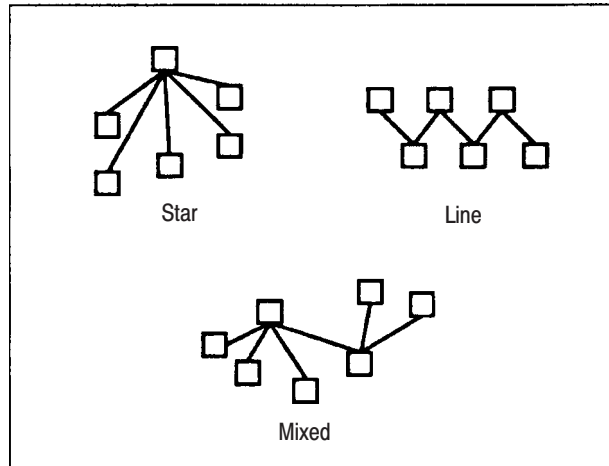

Figure 4-4: Bus configurations

While the star configuration is recommended, configurations can be mixed as long as the total cable length does not exceed 20 meters and the instruments are distributed on the bus according to a few basic rules:

- No more than 15 total devices, including the controller, can be included on a single bus.
- One device load must be connected for every two meters of cable to maintain proper electrical characteristics.
- Each instrument represents one device load on the bus. The 371B represents one device load.

Powering Up

With the 371B connected by GPIB cable to the system and the address and message terminator has been set, the system is ready to power up. Powering up the 371B as part of a GPIB system involves special considerations, as detailed in the following paragraphs.

Powering Up the System Controller and Other Devices. Remember, when powering up a system with several instruments on the bus, at least half of the instruments must be powered up before the controller is brought “on-line.”

Self Test. To turn on the 371B, press the front panel POWER switch. The 371B performs a self-test at power-up and initializes itself to a pre-defined state, after which it’s ready to make measurements. For details of the power-up test, see *Diagnostic Routines and Messages* on page C-1. The power-up default state for the 371B is the same as for the INIt command described on page 4-72.

Power-Up SRQ. When the power-up tests have been completed, the 371B asserts the GPIB line called SRQ. In the interface, the status byte is set to 65.

Controlling the 371B over the bus

As explained in the following discussion, a controller can:

- Send commands to the 371B.
- Send queries and receive responses.
- Control 371B settings.
- Store and transfer 371B data.
- Move waveform data from the 371B.
- Load waveform data to the 371B.
- Transfer cursor and readout data to and from the 371B.

Sending Commands to the 371B

Most GPIB system controllers and their languages provide high level statements for sending device-dependent messages, such as commands, to any system instrument, including the 371B.

These high-level statements usually consist of three parts:

- A key word (PRINT, OUTPUT, WRITE, etc) which causes the action (sending the message over the bus) to occur.
- An address or logical unit number which directs the message to a specific instrument.
- The device-dependent message which is the actual command, query, or data to be recognized by the instrument. (Most controllers delimit the device-dependent message with double quotes.)

The following examples show command strings for two controllers and a representative language for each. The first is an IBM PC with a Tektronix GURU card (or National Instruments model PC2 or PC2A card) running BASICA. The second is a Hewlett Packard 200 or 300 Series Scientific Computer running Series 200 or 300 BASIC.

In these examples, the 371B device-dependent command WINdow (abbreviated as WIN) is used to set the window cursor to midscreen. In the second and third examples, the GPIB address of the 371B is assumed to be "8".

IBM PC: (The address is assigned elsewhere in the code.)

```
200   WRT$="WIN 250,250,750,750"   'Create Command string.
230   CALL IBWRT (DSO%, WRT$)     'Send Command.
```

Hewlett Packard 2001300 Series:

```
200   OUTPUT 708; "WIN 250,250,750,750", END
```

A useful addressing variation assigns the 371B address to a variable and uses that variable in place of the specific numeric address. In the following examples, the address is set to "6". This method works for both the example controllers when running BASIC and allows the destination of several commands to be altered by changing only the value of one variable: this is the scheme used in the IBM PC with the GURU card, running BASICA.

Hewlett Packard 2001300 Series:

```
720  DEVICE=706
730  OUTPUT DEVICE;"250,250,750,750",END
or
720  ASSIGN @DEVICE TO 706
730  OUTPUT @DEVICE;"WIN 250,250,750,750",END
```

The examples in Table 4–2 shown how the syntax of several different controllers can vary.

Table 4–2: Controller Output Syntax

Controller Language	Output Command
IBM PC with BASICA	WRT\$="string" CALL IBWRT(DEV%,WRT\$)
HP 200/300 SERIES BASIC	OUTPUT 710;"STRING",END
HP 9825/200-SERIES HPL	wrt 710,"string"

Sending Queries and Receiving Responses

Commands with a question mark (?) are query commands which solicit information from the 371B. After the controller sends a query command, it must acquire the resulting response from the 371B. Examples using the HOR? query command follow. IBM PC:

IBM PC:

```
150  WRT$="HOR?"
160  CALL IBWRT(DSO%,WRT$)      'Send query.
170  RD$+SPACE$(100)
180  CALL IBRD(DSO%,RD$)      'Input responses.
```

Hewlett Packard 2001300 Series:

```
150  DIM SET$(100)
160  OUTPUT 710;"HOR?",END
170  ENTER 710;SET$
```

In these examples, a string is dimensioned to 100 characters in order to store the incoming information. The controller sends HOR? over the bus to the 371B located at primary address 10. The controller then assigns the instrument at address 10 to be a talker and inputs the characters into the target variable, SET\$. The following shows a possible response, which is a 18 character string. The variable, SET\$, now contains this string of characters showing the current status of the horizontal controls:

HORIZ COLLECT:1E-1

Most commands have a corresponding query command. Table 4-3 shows how query responses are input from a variety of controllers.

Table 4-3: Controller Input Syntax

Controller Language	Input Command
IBM PC with BASICA	IBRD\$(DSO%,RD\$)
HP 200/300 SERIES BASIC	INPUT 710;S\$,END
HP 9825/200-SERIES HPL	red 710,S\$

Instrument Setup Over the Bus

One popular use of the GPIB with the 371B is to store front panel settings for later recall. These stored settings are then used to set up the curve tracer for repeating specific tests. This is accomplished by using a query command to acquire from the 371B an ASCII string representing the front panel setup. This string is saved by the controller. Later, this same setup can be restored by sending the stored string back over the bus to the 371B.

Storing Settings for the 371B. When a setting is transferred, it must first be moved to the front panel. From there it may be moved to the controller or to mass storage. Figure 4-5 shows the transfer routes and the commands.

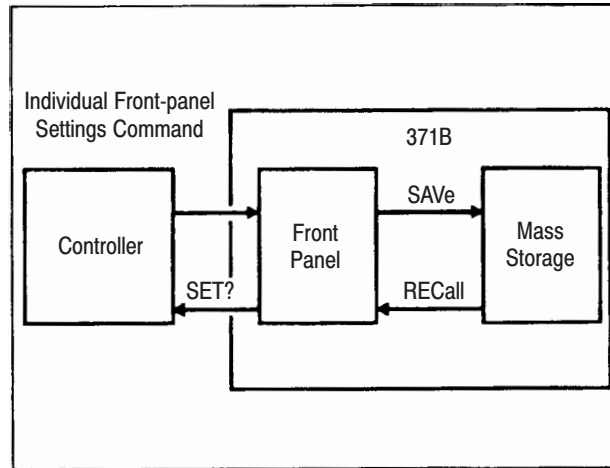

Figure 4-5: Transfer of settings

To bring the 371B front panel setting data into the controller, use the SET? query and put the response into a string variable or variables that can hold up to 500 characters. From there it can be stored on any medium available to the controller, such as magnetic tape or disk.

IBM PC :

NOTE. BASICA is limited to a 255 character maximum string so the IBRD command will have to be executed twice to take in the full possible extend of the settings string.

```

400   WRT$="SET?"           'Set up query command string.
410   RD $=SPACE$(250)     'Assign space for a 250 character
                             response string.
420   RD2$=SPACE$(250)    'Assign space for a 250 character
                             response string.
430   CALL IBWRT(DSO%,WRT$) 'SEND QUERY.
440   CALL IBRD(DSO$,RD$)  'Input response for first 250
                             characters.
450   CALL IBRD(DSO%,RD2$) 'Input response for remaining
                             characters.
  
```

Hewlett Packard 2001300 Series:

```

400   DIM SET$(500)
410   OUTPUT 710;"SET?",END
420   ENTER 710;SET$
  
```

A settings string that is stored by the controller can, of course, be modified. Use the appropriate string manipulation commands in the controller language to search for, modify, or replace parts of the string. Be sure that the resulting string meets the syntax requirements of the 21 individual commands making up the whole and that they are in the proper sequence.

To save the current front panel setting in the mass storage, choose an appropriate setting storage location number of 1 through 70, then send the command `SAVE <number>`, where <number> identifies the setting storage location.

Loading Setting into the 371B. To reverse the above process for settings stored by the controller, simply take the appropriate settings string from wherever it has been stored and send the string back to the 371B. There is no need for any preface or other command since the settings string is made up of the very commands that are needed. When it is necessary to break the setting string, as in BASICA, the break should occur where a semicolon would normally appear and that semicolon should be dropped.

The following examples use the settings strings that were saved in the preceding set of examples.

IBM PC:

```
700 CALL IBWRT(DEV%,SETA$)
710 CALL IBWRT(DEV%,SETB$)
```

Hewlett Packard 2001300 Series:

```
700 OUTPUT 710,SET$,END
```

If the settings were stored in the mass storage, it's necessary to know which of the 80 memory locations was used. Then send the command `RECall <NR1>`, where the number, <NR1>, identifies memory location.

While these procedures can change settings quickly and without error, the operator may have to make a few manual settings (e.g., the OUTPUTS breaker and the position of the protective cover). One way to remind the operator what needs to be done is to send a message using the text display area of the 371B screen. Send an appropriate message of up to 24 characters using the `TEXT <string>` command.

Data Storage and Transfer

Once the 371B has been set up to make a desired measurement, the next step in realizing the advantages of digital storage is to acquire and store the data with the 371B. From the controller you can store it on other media, compare it with other data, calculate with it, or display it. Figure 4-6 shows possible routes for data transfers.

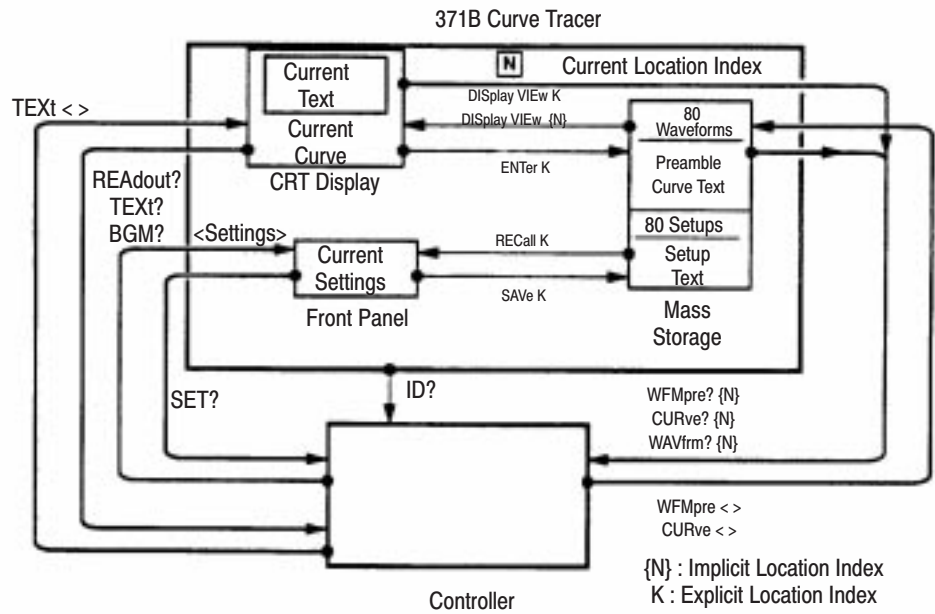

Figure 4-6: Data transfer under GPIB control

In most cases, acquiring data with the 371B involves two parts, both done automatically by the instrument. The first is to code the necessary scale factors and other parameters into a series of words and numbers. The words are English but are standardized so they can also be read by a computer. This part of the data is called the preamble.

The second part of data acquisition is to digitize and code the displayed curves. This converts the curves to a series of binary numbers representing the horizontal and vertical locations of a sequence of points along the curves. This part of the data is called the curve. Together with the preamble it fully describes the displayed curve.

Acquiring Data Within the 371B. To acquire data, set the display function to Store mode. The command to do this over the bus is **DISplay STORE**. At this point the current set of parameters are recorded and the curves being shown are digitized. They can now be copied over the bus to the controller.

Data Structure. The preamble and curve are each a string of eight-bit bytes. The preamble is a string of ASCII letters, numerals, and punctuation. Each character is represented by one byte. The major part of a curve is a sequence of binary-coded numbers, which is prefixed by a 25 character ASCII string identifying the curve.

The curve data string represents the 371B display, where each data point in the display is described as a 10-bit horizontal and 10-bit vertical position. The horizontal and vertical positions are each coded as a pair of bytes in the data string. Thus, there are four bytes for each data point. Since a display can have from 1 to 1024 data points, the curve data can include from 4 to 4096 bytes. In addition, there are two bytes at the start of the string for a byte count and one byte at the end for a checksum value, for a maximum of 4099 bytes.

The numbers are coded in two's-complement binary format. The low-order eight bits are stored in the second byte while the two high-order bits are stored in the low-order positions of the first byte. The sign bit fills the remaining bits in the high-order byte.

Moving Waveform Data to the Controller

Waveform data is transferred from the 371B to the controller in two parts, the preamble and the curve data. As explained in the following discussion, these two parts can be transferred together or separately.

Transferring the Preamble. To receive a waveform preamble from the 371B, send the command query **WFMpre?** The response will be a string containing 17 parameters, each shown as a label and value pair. Follow the command query with an instruction to the controller to input the response, allowing for a string about 320 characters long.

Hewlett Packard 200/300 Series:

```
300 DIM PREAM$(320)
310 OUTPUT 718;"WFM?",END
320 ENTER 718;PREAM$
```

Transferring the Curve. When a waveform is transferred to the controller, it must first be displayed. When a waveform is transferred from the controller it must go directly to the mass storage. The routes and commands are shown in Figure 4–7.

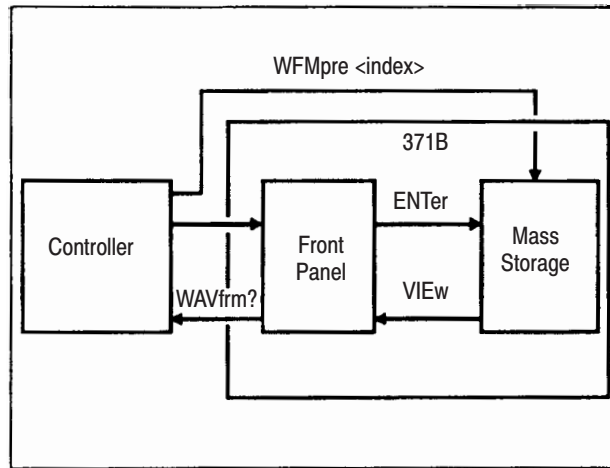

Figure 4–7: Transfer of waveforms

To copy displayed data in Store or View mode to the controller, first send a **WFMpre?** query to transfer the preamble. Then send a **CURve?** query to transfer the curve.

To copy the data from mass storage to the controller, first send a **DISplay VIEW:<index>** command to display the curve stored at the index location. Then send a **WFMpre?** query to transfer the preamble from the display. Last, send a **CURve?** query to transfer the curve from that location. Another command, **WAVfrm?**, combines the functions of **WFMpre?** and **CURve?** and return the whole display, preamble plus curve, with an ASCII semicolon between them.

For the curve data, in general, provisions will have to be made for a string length of about 4125 bytes. The response will be a short (25 bytes or characters) ASCII string identifying the curve, two bytes giving the number (in binary) of data points to follow, the 4096 bytes representing the actual curve data, and a checksum (one binary byte).

Transferring the Waveform to Mass Storage. Another possibility for storing data under control of the bus is to put the waveform into a mass-storage waveform-storage location. Use the **ENTER <NR1>** command, where the number, **<NR1>**, is the storage location index.

Loading Data from the Controller

Moving display data from the controller to the 371B waveform-storage location of 17 through 80 requires that an unlocked floppy disk be in place.

NOTE. *Data transferred from the 371B in Store mode cannot be reloaded to the 371B.*

Loading the Preamble. The command **WFMpre** <string>, where <string> is a waveform preamble, will load that preamble into the 371B. The preamble will be stored in the mass-storage location indicated by the **WFID INDEX** portion of the string (see **WFMpre** in the Command List portion of this section for details).

Loading the Curve.

NOTE. *When sending display data to the 371B, the target is the mass storage location set by the preceding preamble transfer.*

To send a curve from the controller to the 371B, use the command **CURve** <string>, where <string> consists of a short ASCII string (**CURVID**) followed by a string of binary bytes. See **WFMpre** in the Command List portion of this section for details.

Transferring Other Types of Data

Although waveforms are the principal data developed with the 371B, there are two other types of data: cursor readout and text.

Transferring the Cursor Readout. The point at which a dot cursor is located on the display can be expressed in terms of display units. The data is requested with the **REAdout?** command and the response is the **READOUT** followed by a pair of numbers giving the cursor location in terms of physical units: horizontal location in volts and vertical location in amperes. With the **f** Line cursor activated, the response to the **REAdout?** query gives the cursor **ll** gradient in ohms abbreviated as “**OHM**”, and the horizontal intercept in volts. The window cursor can be used similarly but the readout value depends on the last manual setting as to whether it comes from the upper-right or lower-left corner of the rectangular window.

Transferring Text. Although it's not data in the same sense, information in the text display area can be read over the bus with the **TEXt?** query command. Text can also be replaced in the display with the **TEXt** command, as described in the Command List portion of this section.

Device-Dependent Message Format

Device-dependent messages travel both ways between the instrument and controller, and are used to:

- Set instrument controls.
- Request and return the instrument status.
- Request, return, and send waveforms.
- Request and return results of other measurements.

Most messages are sent as strings of ASCII characters; however, data representing sets of curves are sent as series of binary-coded numbers.

Commands are sent from the controller to the instrument. Each starts with a key word called a header which is usually followed by an argument to further detail the instruction. The key words used for command headers and arguments are mnemonics related to specific instrument controls and functions. Multiple commands can be sent in one message. Many command headers can be issued with an attached question mark (?), identifying them as queries which prompt the instrument for certain information.

Response to queried either contain information about instrument status or measurement data. Generally, status messages are made up of the same key words used for commands. The only device-dependent message not made up of words or parts of words are those made up of curve data.

Each message ends with the message terminator, which was discussed earlier. In most cases the controller or its language takes care of the message terminator and it is no longer a concern once it has been chosen and set.

Command Message Formats

Commands for the 371B Curve Tracer, like those for other Tektronix GPIB instruments, follow the conventions of the Tektronix Standard Codes and Formats. Each command starts with a key word header which is often followed by one or more key word arguments to further specify the action to be taken. The key words for commands were chosen to be as understandable as possible, while still allowing a familiar use to shorten most of them to only a few characters. Syntax is also standardized to make the commands easier to learn.

In most of this section, key words for headers and arguments are listed in a combination of uppercase and lowercase letters. The instrument accepts any abbreviated header or argument containing at least all the characters shown in uppercase. We show them as uppercase for emphasis only. The 371B accepts upper or lower case characters. In many cases, the commands may be expressed in a variety of valid ways.

The following are all valid versions of the INIt command, which resets the 371B to the initial state following power-up.

```
INI
INrr
Ini
Init
ini
init
inIT
```

The Command List portion of this section describes all the 371B commands and queries. In the Command List, the elements of each command and query are listed in tabular format. The first column lists the header key word. The second column lists arguments that may be associated with the command. A third column if necessary, lists linked arguments. Brief descriptions and examples are shown in the last column.

Headers. Each command consists of at least a header.

```
<header>
```

Each command header is unique and in some cases is all that is needed to invoke the command. For example:

```
INIt
```

NOTE. *CURSor can be shortened only to four characters. The three characters CUR will be interpreted as CURve.*

Arguments. Many commands require the addition of arguments to the header to describe exactly what is to be done. If there is more to the command than just the header, the header must be followed by at least one space. Otherwise, the 371B treats all spaces, line feeds, and tabs as “white space” and ignores them in analyzing messages from the controller. For example:

```
<header> <argument>
```

In some cases, the argument is simply a single word or a number. For example:

```
CURSor OFF
RQS on
PKPower 3000
```

Linked Arguments. In other cases, the argument itself requires another argument. When an argument to an argument is required, a colon links the two; hence the second is called a linked argument.

<header> <argument>:<linked argument>

DISplay INVert:ON
VERt COLlect:1.0E+0
WFMpre NR.PT:512

Queries. For most commands there is a corresponding query formed by adding a question mark to the header key word. Do not put a space between the last character of the key word and the question mark.

Queries for the 371B need only the header and question mark, though the response will usually be more involved.

<header>?

ID?
HOR?
DEB?
STPgen?

Query:	STP?
Typical Response:	STPGEN NUMBER: 5,PULSE:OFF, OFFSET: 0.00,INVERT:OFF, MULT:OFF, CURRENT: 1.0E-3

Multiple Arguments. Where a header has multiple arguments, the successive arguments (or argument pairs if the arguments have linked arguments) must be separated by commas.

<header> <first arg>:<link arg>, <second arg>:<link arg>

STP CUR: 2E-3, MUL:ON, NUM:5
DIS VIE:16, REF:ON

Numeric Arguments Formats. Many Commands have numeric arguments. The numbers are decimal (base 10) values. They are expressed in three different formats, denoted <NR1>, <NR2>, and <NR3>. These formats are shown in Table 4-4.

Table 4-4: Numeric Argument Formats

Symbol	Number Format	Examples
<NR1>	Integer	+1, 2, -1, -10, 0
<NR2>	Explicit decimal point	-3.2, +5.1, 1.2, .0, 0.
<NR3>	Floating point, exponential, or scientific notation	-12.3 E -2, .005E-6, 0.000E-3, 6.7E+4, 2.35E-3, 0.E0, 125E-6

Generally:

An <NR1> argument must be sent to the 371B in that format (i.e., without a decimal point).

An <NR2> argument may be sent to the 371B in either <NR2> or <NR1> format.

An <NR3> argument may be sent in <NR3>, <NR2> or <NR1> format.

Examples of these argument formats are shown in Table 4-5.

Table 4-5: Argument Format Examples

Command	Valid Forms
RECall <NR1>	REC 12
DISplay VIEw: <NR1>	DIS VIE: 7
STPgen OFFset: <NR2>	STPGEN OFFSET: 5 stp off: 3.5
VERt COLlect: <NR3>	VER COL: 2 VER COL: 0.5 vert collect: 1.5E-2

Multiple-Command Messages. Multiple commands may be included in one message by separating individual commands with semicolons. The command examples are shown in different formats to demonstrate the 371B indifference to upper and lower case.

<first command>;<second command>;<third command>

PKPOWER 30;CSPOL NPN;MEASURE SINGLE

pkpow 30;cspol npn;meas single

PKP 30;CSP NPN;MEA SIN

CURSOR OFF;HORIZ STPGEN:1.0E+0;STPGEN NUMBER:3

With multiple commands in the message, the message terminator is needed only once, at the end of the message. Again, most controllers and their languages take care of this.

Other Messages. Besides receiving commands and queries the 371B can receive data and send responses to queries. The data and responses can be quite short (a word and a number) or fairly long (a full set of front panel settings). Measurement information can also be short (a word and a number) or lengthy (a full display).

ASCII strings. As mentioned before, the only device-dependent messages not sent as ASCII strings are the binary data used for curves. All other messages, both to and from the 371B, are ASCII strings made up of numbers or key words pertaining to the applicable parameters.

Key word messages. A sample, key word exchange resulting in a simple response is the following.

```
Query:      PST?
Response:   STATUS BUSY
```

Another example follows, this one resulting in a more lengthy response.

```
Query:      STP?
Response:   STPGEN OUT:ON, NUMBER:2, OFFSET:1.5,
            INVERT:OFF, MULT:OFF, VOLTAGE:200.0E-3
```

Number message. Numbers other than those representing curves are sent as strings of ASCII characters. Some controllers may require that these be explicitly converted to numeric values for use in calculations. Other controllers or languages may provide a more direct conversion.

Preambles. Preambles are necessary to interpret the numeric information in the curve data that follows them. Within a preamble, 26 parameters are specified. The first ten are unique to the 371B curve tracer and are included as a sub-string linked to the WFID: label. The other 16 parameters include ten that have fixed values and six that vary with the particular data sent.

Within the WFID: sub-string the parameters are separated by slashes, while the entire sub-string is delimited by a pair of double quote marks. Most of the WFID: string is rather strictly defined, with each parameter value being right justified in a fixed length field. An exception is the BGM value, which may vary in field length.

The remainder of the preamble uses standard punctuation. A colon links each parameter label with its corresponding value and the individual label and value pairs are separated with commas.

A complete preamble might look like this:

```
WFMPRE WFID:"INDEX 3/VERT 500MA/ HORIZ 1V/STEP 5V/OFFSET
0.00V/BGM 100mS/VCS 12.3/TEXT /HSNS VCE",ENCDG:BIN,
NR.PT:3,PT.FMT:XY,XMULT:+1.0E-2,XZERO:0,XOFF:
12,XUNIT:V,YMULT:+5.0E-3,YZERO:0,YOFF:12,YUNIT:A,BYT/
NR:2,BN.FMT:RP,BIT/NR:10,CRVCHK:CHKSMO,LN.FMT:DOT
```

Curves. Curve data sets are usually much longer than any other kind. Typically a set of curve data will be about 4122 bytes long, with most of the bytes being binary-coded numbers. Thus, most of the string of data is not directly readable, but must be interpreted by the controller.

An example might look like this.

```
CURVE CURVID:"INDEX 9",%NNXXYYXXYY . . . XXYYC
```

This example breaks down as follows. It starts with an ASCII string of 25 characters:

```
CURVE CURVID:"INDEX 9",%
```

This is followed by a series of binary bytes. The first of these is two bytes giving the number of data bytes to follow, plus one (typically 4097):

```
NN
```

Then come the 4096 data bytes. Each of the 1024 data points on the curve is represented by four bytes, 2 for the 10 bits of the X coordinate and 2 for the 10 bits of the Y coordinate:

```
XXYYXXYY . . . XXYY
```

And finally there is one byte which is the checksum for the preceding 4098 data bytes.

371B GPIB Commands

Introduction 371B GPIB commands are divided into three classes, the front panel control commands, display data and CRT readout I/O commands, and the system commands. Each class has several command groups, sorted by function.

Front Panel Control Commands and Queries

Front-panel-related commands and queries are grouped as follows:

- Display Controls
- Cursor Controls
- Collector Supply Controls
- Step Generator Controls
- Configuration
- Measurement
- Others

Table 4–6 relates the front panel controls to the GPIB commands.

Table 4–6: GPIB Commands and Queries for Front-Panel Controls

371B Control	Command	Query	Group
CRT Controls			
NON STORE/STORE/VIEW	none	none	none
Intensity			
REF Intensity	none	none	none
READOUT Intensity	none	none	none
FOCUS	none	none	none
GRAT ILLUM	none	none	none
POSITION	none	none	none
TRACE ROTATION	none	none	none
Measurement Controls			
REPEAT	MEAsure	MEAsure	Miscellaneous
SINGLE	MEAsure	MEAsure	Miscellaneous
SWEEP	MEAsure	MEAsure	Miscellaneous
Memory Controls			
Memory location number	Selected only as an argument when saving and recalling settings or waveforms.		
Setup Controls			
SAVE	SAVe	none	Miscellaneous
FORMAT	none	none	none

Table 4-6: GPIB Commands and Queries for Front-Panel Controls (Cont.)

371B Control	Command	Query	Group
RECALL	RECall	none	Miscellaneous
DIRECTORY	none	none	none
Display Controls			
NON STORE	DISplay	DISplay?	Display
STORE	DISplay	DISplay?	Display
	CURve	CURve?	Waveform transfer
			Waveform transfer
CAL FULL	DISplay	DISplay?	Display
REF	DISplay	DISplay?	Display
CAL OFF	DISplay	DISplay?	Display
VIEW	DISplay	DISplay?	Display
CAL ZERO	DISplay	DISplay?	Display
ENTER	ENTer	-	Display
TEXT	TEXT	TEXT?	CRT readout
			Transfer
HORIZONTAL VOLTS/DIV	HORiz	HORiz?	Display
VERTICAL CURRENT/DIV	VERT	VERT?	Display
INVERT	DISplay	DISplay?	Display
Collector Supply Controls			
POLARITY	CSPol	CSPol?	Collector Supply
PEAK POWER WATTS	PKPower	PKPower?	Collector Supply
VARIABLE	VCSpply	VCSpply?	Collector Supply
LOOPING COMPENSATION	none	none	none
Step Generator Controls			
INVERT	STPgen	STPgen?	Step Generator
SOURCE	STPgen	STPgen?	Step Generator
NUMBER OF STEPS	STPgen	STPgen?	Step Generator
STEP/OFFSET AMPLITUDE	STPgen	STPgen?	Step Generator
OFFSET	STPgen	STPgen?	Step Generator
STEP MULTI .1X	STPgen	STPgen?	Step Generator
DISABLE	STPgen	STPgen?	Step Generator
Cursor Controls			
Cursor Mode	CURsor	none	Cursor

Table 4-6: GPIB Commands and Queries for Front-Panel Controls (Cont.)

371B Control	Command	Query	Group
Cursor Position	DOT	none	Cursor
	WIN dow	none	Cursor
	LINE	none	Cursor
		REAd out?	CRT readout
			Transfer
		DOT	DOT?
	WIN dow	WIN dow?	Cursor
	LINE	LINE?	Cursor
GPIB Controls			
RESET TO LOCAL	none	none	none
ADDR	none	none	none
USER REQUEST	none	none	none
ID	-	ID?	Instrument Parameters
CURVE			Miscellaneous
Signal Output Controls			
Collector Supply	none	CSOut?	Collector Supply
Breakers			

Table 4-7: General Setting Information and Related GPIB Commands

Setting Information	Command or Query	Group
Set the 371B controls to the power-up default settings	INI t	Instrument Parameters
What are the current 371B	SET?	Instrument Parameters
What are the valid command	HEL p?	Instrument Parameters

Command Reference

The 371B has commands and queries in nine function groups:

- Collector Supply: control and report collector supply settings.
- CRT Readout Transfer: read and write display text and report the cursor readout.
- Cursor: control and report cursor position and set cursor mode.
- Instrument Parameter: initialization, troubleshooting, and status reporting.
- Miscellaneous: control and report measurement mode and report output connector status, store and recall front panel settings.
- Status and Event: control and report service requests and event codes.
- Waveform Transfer: store and recall waveforms.

Table 4–8 shows the nine groups and the commands within each group. Detailed descriptions of each command are provided in the order as listed in this table.

The “Command Index” (following Table 4–8) lists all commands and queries alphabetically and gives the page on which they are described.

Table 4–8: Command and Query Groups

Query Group	Command
Collector	CSPol CSPol? CSOut? PKPower PKPower? VCSpply VCSpply?
CRT Readout Transfer	BGM? REAdout? TEXT TEXT?

Table 4-8: Command and Query Groups (Cont.)

Query Group	Command
Cursor	CUR sor DOT DOT? LINE LINE? WIN dow WIN dow?
Display	DIS play DIS play? ENT er HOR iz HOR iz? VER t VER t?
Instrument Parameter	DEB ug DEB ug? HEL p? ID? INI t SET? TES t?
Miscellaneous	MEAS ure MEAS ure? OUT puts? PLO t RE call SAV e
Status and Event	EVE nt? OPC OPC? RQS RQS?

Table 4-8: Command and Query Groups (Cont.)

Query Group	Command
Step Generator	STPgen
	STPgen?
Waveform Transfer	CURve
	CURve?
	WAVfirm?
	WFMpre
	WFMpre
	WFMpre?
	WFMpre NR.PT
	WFMpre? NR.PT

Command Index

The following is an alphabetical index of the command reference descriptions:

BGM?	4-47
CSOut?	4-39
CSPol	4-40
CSPol?	4-41
CURsor	4-52
CURve	4-93
CURve?	4-94
DEBug	4-68
DEBug?	4-69
DISplay	4-60
DISplay?	4-61
DOT	4-53
DOT?	4-54
ENTer	4-62
EVEnt?	4-84
HELp?	4-70
HORiz	4-63
HORiz?	4-64
ID?	4-71
INIt	4-72
LINE	4-55
LINE?	4-56
MEASURE	4-76
MEASURE?	4-77
OPC	4-85
OPC?	4-86
OUTput?	4-78
PKPower	4-42
PKPower?	4-43
PLOt	4-79
PStatus?	4-80
READout?	4-48
RECall	4-81
RQS	4-87
RQS?	4-88
SAVe	4-82
SET?	4-73
STPgen	4-90
STPgen?	4-91
TESt?	4-74
TEXT	4-49
TEXT?	4-50
VCSply	4-44
VCSply?	4-45
VERt	4-65

VERt? 4-66

WAVfrm? 4-95

WFMpre 4-96

WFMpre? 4-97

WFMpre NR.PT 4-98

WFMpre? NR.PT 4-99

WINDow 4-57

WINDow? 4-58

**Collector Supply
Commands and Queries**

The Collector Supply group of commands and queries sets and reports the status of the collector supply polarity, mode, peak power, and output level. They also query the 371B on the status of the collector supply HIGH CURRENT and HIGH VOLTAGE breakers, which cannot be set via the GPIB.

The commands and queries in this group include:

CSOut?
CSPol
CSPol?
PKPower
PKPower?
VCSply
VCSply?

An alphabetical listing of all command and query headers is given in the “Command Index .”

A cross reference for front-panel controls and corresponding GPIB commands and queries is also given in Table 4-6.

CSOut?

Group Collector Supply

Purpose Queries the 371B for the current setting of the collector supply HIGH VOLTAGE and HIGH CURRENT breakers.

Header	Argument	Definition and Syntax
CSOut?		Respond with the collector supply breaker status.
		Response syntax: CSOut <mode>
		Where: <mode>= BOTH or VOLTAGE or CURRENT or OFF
		and
		BOTH = Both the HIGH VOLTAGE AND HIGH CURRENT breakers are enabled.
		VOLTAGE = HIGH VOLTAGE breaker is enabled and HIGH CURRENT breaker is disabled.
		CURRENT = HIGH CURRENT breaker is enabled and HIGH VOLTAGE breaker is disabled.
		OFF = Both the HIGH VOLTAGE AND HIGH CURRENT breakers are disabled.

CSPol

Group Collector Supply

Purpose Sets the collector supply polarity and mode.

Header	Argument	Definition and Syntax
CSPol	NPN POSitive PNP NEGative	Select the collector supply polarity and mode. Command syntax: CSPol <mode> where: <mode>= NPN, POSitive, PNP, or NEGative

CSPol?

Group Collector Supply

Purpose Queries the 371B for the current setting of the collector supply polarity.

Header	Argument	Definition and Syntax
CSPol?		Respond with the collector supply polarity. Respond syntax: CSPOL <mode> where: <mode>= NPN or PNP

PKPower

Group Collector Supply

Purpose Sets the collector supply peak power watts setting.

Header	Argument	Definition and Syntax
PKPower	3000	Set the maximum peak power, in watts.
	300	Command syntax: PKPower <set> where: <set> = 3000 or 300 or 30 or 3 or 0.3 or 0.03
	30	
	3	
	.3	
	.03	

PKPower?

Group Collector Supply

Purpose Queries the 371B for the current setting of the collector supply peak power watts setting.

Header	Argument	Definition and Syntax
PKPower?		Respond with the maximum peak power setting, in watts. Response Syntax: PKPower <set> where: <set> = 3000 or 300 or 30 or 3 or 0.3 or 0.03

VCSply

Group Collector Supply

Purpose Sets the collector supply output level.

Header	Argument	Definition and Syntax
VCSply	<NR2>	<p>Set the collector supply output level (variable). The argument is stated as a percentage with allowed increments of 0.1 %.</p> <hr/> <p>Command syntax: VCSply <data></p> <p>where:</p> <p><data> = 0.0 or 0.1 99.9 or 100.0</p>

VCSpply?

Group Collector Supply

Purpose Queries the 371B for the current setting of the collector supply output level.

Header	Argument	Definition and Syntax
VCSpply?		Respond with the collector supply output level (variable) setting. Response Syntax: VCSpply <data> where: <data> = 0.0 or 0.1 ... 99.9 or 100.0

**CRT Readout Transfer
Commands and Queries**

The CRT Readout Transfer group allows the controller to read horizontal and vertical cursor parameters from the 371B, and to read or write text in the text area of the display graticule.

The commands and queries in this group include:

BGM?
REAdout?
TEXT
TEXT?

An alphabetical listing of all command and query headers is given in the “Command Index”.

A cross reference for front-panel controls and corresponding GPIB commands and queries is also given in Table 4–6.

BGM?

Group CRT Readout Transfer

Purpose Queries the 371B for the β or gm/DIV readout.

Header	Argument	Definition and Syntax
BGM?		Respond with the β or gm/DIV readout from the display. <hr/> Respond syntax: BGM <para> where: <para> = <NR1>

REAdout?

Group CRT Readout Transfer

Purpose Queries the 371B for the vertical and horizontal cursor parameter readouts.

Header	Argument	Definition and Syntax
REAdout?	default STRing SCientific	<p>The default argument is STRing.</p> <p>Window cursor values are for the location of the bright dot in the corner of the window cursor. The window cursor used depends on the last cursor mode setting made at the front panel.</p> <p>The response can be specified to be in either string or scientific notation format.</p> <p>If the cursor is offscreen, the returned values will be preceded by question marks and are not valid.</p> <p>Note also the commands for cursor positioning in the Cursor Commands and Queries group.</p> <hr/> <p>Response syntax:</p> <p>READOUT <xread>,<yread></p> <p>where:</p> <p><xread> = horizontal reading in volts</p> <p><yread> = vertical reading in amperes (ohm or siemens for f line cursor)</p> <p>When queried with the SCientific argument, the responses <xread> and <yread> are <NR3>.</p>

TEXT

Group CRT Readout Transfer

Purpose Allows the controller to write text on the 371B display.

Header	Argument	Definition and Syntax
TEXT	<string>	Display the text string in the text display area of the CRT graticule. <hr/> Command syntax: TEXT "<text>" where: <text> = a message with a length of no more than 24 characters.

TEXT?

Group CRT Readout Transfer

Purpose Queries the 371B for any text displayed in the text area of the CRT graticules.

Header	Argument	Definition and Syntax
TEXT?		<p>Respond with the text currently displayed in the text area of the CRT.</p> <p>Although text may be stored in mass storage along with the settings, it can be sent over the bus with this query.</p> <hr/> <p>Response syntax: TEXT "<text>"</p> <p>where:</p> <p><text> = a message with a length of no more than 24 characters.</p>

CRT Commands and Queries

The Cursor group selects Cursor mode and positions the selected cursor on the display, or queries the 371B on the position of the cursor.

The commands and queries in this group include:

CURSoR
DOT
DOT?
LINE
LINE?
WINdow
WINdow?

An alphabetical listing of all command and query headers is given in the “Command Index”.

A cross reference for front-panel controls and corresponding GPIB commands and queries is also given in Table 4-6.

CURSor**Group** Cursor**Purpose** Sets the 371B mode to off.

Header	Argument	Definition and Syntax
CURSor	OFF	Set the cursor mode to OFF. Command syntax: CURSor OFF Also see the REAdout? query in the CRT Readout Command group for extracting data from the cursor.

DOT

Group Cursor

Purpose Sets the 371B dot cursor position to a specific point on the currently displayed curve.

Header	Argument	Definition and Syntax
DOT	<NR1>	<p>Set the dot cursor on the specified data point in the current curve.</p> <p>Command syntax: DOT <data></p> <p>where: <data> = 1 or 2 or 3 1024 (0 is the beginning of the curve and 1024 is the end.)</p>

DOT?

Group Cursor

Purpose Queries the 371B for the location of the dot cursor on the currently displayed curve.

Header	Argument	Definition and Syntax
DOT?		Respond with the dot cursor position. Response syntax: DOT <NR1> where: <NR1> = a number between 0 and 1024 specifying the location of the dot cursor on the currently displayed curve. (Zero is the beginning of the curve and 1024 is the end.)

LINE

Group Cursor

Purpose Sets the f line cursor intercept position on the display.

Header	Argument	Definition and Syntax
LINE	<NR1>, <NR1>	<p>Set the f line cursor intercept position. This position must be a point on a square grid whose bottom left corner coordinates are 0, 0 and top right corner coordinates are 1000, 1000.</p> <hr/> <p>Command syntax: LINE <data1>,<data2></p> <p>where:</p> <p><data1> = 0 1000 horizontal position</p> <p><data2> = 0 1000 vertical position</p>

LINE?

Group Cursor

Purpose Queries the 371B for the intercept position on the f line cursor on the display.

Header	Argument	Definition and Syntax
LINE?		<p>Respond with the f line cursor intercept position. This position is a point on a square grid whose bottom left corner coordinates are 0, 0 and top right corner coordinates are 1000, 1000.</p> <hr/> <p>Response syntax:</p> <p>LINE <data1>,<data2></p> <p>where:</p> <p><data1> = 0 1000 horizontal position</p> <p><data2> = 0 1000 vertical position</p>

WINdow

Group Cursor

Purpose Positions and sizes the window cursor on the CRT graticules.

Header	Argument	Definition and Syntax
WINdow	<NR1>, <NR1>, <NR1>, <NR1>	<p>Set the window cursor to the specified position on the CRT graticule. (The cursor window is defined by four points, which are specified in the argument portion of the command.)</p> <hr/> <p>Command syntax: WINdow <data1>,<data2>,<data3>,<data4></p> <p>where:</p> <p><data1> = 0 1000 (bottom left horizontal position) <data2> = 0 1000 (bottom left vertical position) <data3> = 0 1000 (bottom right horizontal position) <data4> = 0 1000 (bottom right vertical position)</p>

WINdow?

Group Cursor

Purpose Queries the 371B for the positions and sizes the window cursor on the CRT graticules.

Header	Argument	Definition and Syntax
WINdow?		<p>Respond with the window cursor position (The cursor window is defined by four points, which are specified in the argument portion of the response).</p> <hr/> <p>Response syntax: WINdow <data1>,<data2>,<data3>,<data4></p> <p>where:</p> <p><data1> = 0 1000 (bottom left horizontal position) <data2> = 0 1000 (bottom left vertical position) <data3> = 0 1000 (bottom right horizontal position) <data4> = 0 1000 (bottom right vertical position)</p>

Display Commands and Queries

The Display group of commands and queries controls and reports the status of the display. The 371B settings controlled by this group include: mode, polarity, source, sensitivity, and calibration mode. Also included by this group is a command to send store-mode displays to specified location in mass storage.

The commands and queries in this group include:

DISplay
DISplay?
ENTer
HORiz
HORiz?
VERt
VERt?

An alphabetical listing of all command and query headers is given in the “Command Index”.

A cross reference for front-panel controls and corresponding GPIB commands and queries is also given in Table 4-6.

DISplay

Group Display

Purpose Set and change the display mode, polarity, and the calibration mode.

Header	Argument	Linked Argument	Definition and Syntax
DISplay	NSTore		Select non-store mode.
	STOre		Select store mode. Command syntax: DISplay <mode> where: <mode> = NSTore or STOre
	VIEW:	<NR1>	Select view mode and display a curve from the specified location. Command syntax: DISplay <mode>:<index> where: <mode> = VIEW <index> = 1 80 (memory index)
	REF:	ON OFF	Display reference curve. Turns off the reference curve display. Command syntax: DISplay <mode>:<status> where: <mode> = REF <status> = ON or OFF
	INVert:	ON OFF	Set the display invert mode. Reset normal display mode. Command syntax: DISplay <mode>:<status> where: <mode> = INVert <status> = ON or OFF
	CAL:	ZERo OFF FULI	Set the CRT calibration mode. Command syntax: DISplay <mode>:<status> where: <mode> = CAL <status> = ZERo or OFF or FULI

DISplay?

Group Display

Purpose Queries the 371B for the current settings of the display, polarity, and calibration mode.

Header	Argument	Definition and Syntax
DISplay?		Respond with the current display settings. Response syntax: DISplay <mode1>,<mode2>,<mode3>,<mode4> where: <mode1> = INVERT:OFF or INVERT:ON <mode2> = CAL:ZERO or CAL:OFF or CAL:FULL <mode3> = NSTORE or STORE or VIEW:<NR1> <mode4> = REF:OFF or REF:ON

ENTer

Group Display

Purpose Store the display in mass storage.

Header	Argument	Definition and Syntax
ENTer	<NR1>	<p>Store the displayed curve data in the specified memory location. (This command is valid only in store or view mode.)</p> <hr/> <p>Command syntax: ENTer <index></p> <p>where: <index> = 1 80 (memory location)</p>

HORiz

Group Display

Purpose Set the 371B horizontal display source and sensitivity.

Header	Argument	Linked Argument	Definition and Syntax
HORiz	STPgen: COLlect:	<NR3> <NR3>	<p>Select the horizontal display source and sensitivity (volts/div).</p> <hr/> <p>Command syntax: HORiz <source>:<volt></p> <p>where: <source> = COLlect or STPgen</p> <p>When <source> is COLlect:<volt> may be:</p> <ul style="list-style-type: none"> ■ 1.0E-1 to 5.0E+0 if peak watts is set to 3 KW/300 W. ■ 5.0E+1 to 5.0E+2 if peak watts is set to 30 W/3 W. ■ 5.0E+0 to 5.0E+1 if peak watts is set to 300 mW or 30 mW. <p>When <source> is STPgen:<volt> may be 1.0E-1 to 5.0E+0.</p>

HORiz?

Group Display

Purpose Queries the 371B for the current horizontal source and sensitivity settings.

Header	Argument	Definition and Syntax
HORiz?		Response with horizontal display source and sensitivity. <hr/> Response syntax: HORiz <source>:<volt> where: <source> = COLLECT or STPGEN <volt> = sensitivity (volt/div) <NR3>

VERt

Group Display

Purpose Set the vertical sensitivity of the 371B.

Header	Argument	Linked Argument	Definition and Syntax
VERt	COLlect:	<NR3>	<p>Set the vertical sensitivity (A/div). The source, COLlect, is required as the argument.</p> <hr/> <p>Command syntax: VERt COLlect:<amp></p> <p>where:</p> <p><amp> = 1.0E+0 to 5.0E+1 when peak watts is 3 KW.</p> <p><amp> = 500.0E-3 to 5.0E+0 when peak watts is 300 W.</p> <p><amp> = 1.0E-4 to 5.0E-3 when peak watts is 30 W.</p> <p><amp> = 1.0E-5 to 5.0E-4 when peak watts is 3 W or 300 mW.</p> <p><amp> = 1.0E-6 to 5.0E-5 when peak watts is 30 mW.</p>

VERT?

Group Display

Purpose Queries the 371B for the vertical sensitivity settings.

Header	Argument	Definition and Syntax
VERT?		<p>Response with vertical display source and sensitivity.</p> <p>COLLECT is always given as the source in the argument portion of the query.</p> <hr/> <p>Response syntax: VERT COLlect:<amp></p> <p>where: <amp> = sensitivity (A/div)</p>

Instrument Parameter Commands and Queries

The Instrument Parameter commands and queries group is helpful for determining the status of the 371B when problems are encountered. The 371B can be queried for its firmware version, all current settings, a list of all valid command and query headers, and whether debug mode is enabled. A command is included in this group to place the 371B into a known operating condition by initializing most front-panel settings.

For active troubleshooting, the 371B can be placed in debug mode to display the last 15 characters of a received string. A test routine is available to report back ROM and RAM problems.

The commands and queries in this group include:

DEBug
DEBug?
HELp?
ID?
INIt
SET?
TESt?

An alphabetical listing of all command and query headers is given in the “Command Index”.

A cross reference for front-panel controls and corresponding GPIB commands and queries is also given in Table 4–6.

DEBug

Group Instrument Parameter

Purpose Sets the debug mode.

Header	Argument	Definition and Syntax
DEBug	ON OFF	Enable or disable the debug feature. When ON, the 371B momentarily displays the last 15 characters of the received string in the error message area of the display. Command syntax: DEBug <status> where: <status> = ON or OFF

DEBug?

Group Instrument Parameter

Purpose Queries the 371B for the status of the debug mode.

Header	Argument	Definition and Syntax
DEBug?		Respond with the status of the debug mode. Response syntax: DEBUG <status> where: <status> = ON or OFF

HELp?

Group Instrument Parameter

Purpose Ask the 371B for a list of all valid command and query headers.

Header	Argument	Definition and Syntax
HELp?		Respond with a list of all valid command and query headers. Response syntax: HELP READOUT, TEXT, LINE, DOT, WINDOW, CURSOR, BGM, DISPLAY, HORIZ, VERT, STPGEN, MEASURE, ENTER, RECALL, SAVE, PLOT, PSTATUS, PKPOWER, CSPOL, CSOUT, VCSPPLY, OUTPUTS, WFMPRE, CURVE, WAVFRM, RQS, OPC, EVENT, TEST, INIT, ID, DEBUG, SET

ID?

Group Instrument Parameter

Purpose Queries the 371B for its firmware version.

Header	Argument	Definition and Syntax
ID?		Respond with the 371B ID. <hr/> Response syntax: ID SONY_TEK/371B, V81.1F <version> where: <version> = current firmware version

INIt

Group Instrument Parameter

Purpose Initializes the 371B to its power-up settings.

Header	Argument	Definition and Syntax
INIt		Initializes the instrument. Settings are the same as at power-up and are shown below.
	Function	INIt Value
	DISplay	STORE
	CURSor	OFF
	DISplay CAL:	OFF
	DISplay: INV:	OFF
	DISplay: REF:	OFF
	STP CUR:	1.0E-3
	STP OFF:	0.00
	STP INV:	OFF
	PKPower	300
	CSPol	NPN
	HORiz COL:	1.0E+0
	OPC	OFF
	MEAsure	REPEAT
	STP NUM:	2
	STP MUL:	OFF
	VCSply	0.0
	VERt COL:	1.0E+0
	RQS	On
	DEBbug	OFF

SET?

Group Instrument Parameter

Purpose Queries the 371B for its current front-panel settings.

Header	Argument	Definition and Syntax
SET?		<p>Respond with the front-panel settings.</p> <hr/> <p>Response syntax: OPC<mode>;RQS<mode>;PKPOWER<watts>; CSPOL,<polarity>;HORIZ<source:size>;VERT COLLECT:<size>; STPGEN OUT:<mode>;NUMBER:<number>;OFFSET:<offset>; IN- VERT:<mode>;MULT:<mode>;<source:size>;VCSPPLY:<mode>; CAL:<mode>;<display mode>;REF:<mode>;TEXT"<text>"; CURSOR<mode></p> <hr/> <p>Response syntax [when the measurement mode is SWEp or SSWeep (slow sweep)]: OPC<mode>;RQS<mode>;PKPOWER<watts>; CSPOL,<polarity>;HORIZ<source:size>;VERT COLLECT:<size>; STPGEN OUT:<mode>;NUMBER:<number>;OFFSET:<offset>; INVERT:<mode>;MULT:<mode>;<source:size>; VCSPPLY<percent>;DISPLAY INVERT:<mode>; CAL:<mode>;<display mode>;REF:<mode>;MEASURE SWEEP; TEXT"<text>";CURSOR<mode></p>

TEST?

Group Instrument Parameter

Purpose Perform tests on the ROM and RAM.

Header	Argument	Definition and Syntax
TEST?		Perform ROM and RAM checks and respond with the result. <hr/> Response example (with no error found): TEST ROM:00000, RAM:0000 NOTE: Refer to "GPIB Diagnostics" in Chapter 3: Maintenance of the 371B Service manual for codes other than 0000.

**Miscellaneous Commands
and Queries**

The miscellaneous commands and queries group contains queries for the status of the output connectors, and the measurement code, as well as commands to set the measurement mode and save and recall sets of front-panel settings.

The commands and queries in this group include:

MEASure
MEASure?
OUTputs?
PLOt
PStatus?
RECall
SAVe

An alphabetical listing of all command and query headers is given in the “Command Index”.

A cross reference for front-panel controls and corresponding GPIB commands and queries is also given in Table 4–6.

MEASURE

Group Miscellaneous

Purpose Selects the measurement mode.

Header	Argument	Definition and Syntax
MEASURE	REPEAT SINGLE SWEEP SWEEP?	Select the measurement mode. Command syntax: MEASURE <mode> where: <mode> = REPEAT or SINGLE or SWEEP or SSWEEP

MEASURE?

Group Miscellaneous

Purpose Queries the 371B for the current measurement mode setting.

Header	Argument	Definition and Syntax
MEASURE?		Respond with the current measurement mode setting. <hr/> Response syntax: MEASURE <mode> where: <mode> = REPEAT or SINGLE or SWEEP or SSWEEP

OUTput?

Group Miscellaneous

Purpose Queries the 371B for the status of the output connectors.

Header	Argument	Definition and Syntax
OUTput?		Respond with the status of the output connectors. <hr/> Response syntax: OUTPUT <status> where: <status> = ENABLED or DISABLED and ENABLED = all connector outputs enabled except interlock. DISABLED = all connector outputs disabled except interlock.

PLOt

Group Miscellaneous

Purpose Defines which data will be printed and starts the printing process.

Header	Argument	Definition and Syntax
PLOt	ALL CURve	<p>Select the printer interface mode, curve only or curve plus readout and graticule, and start the output to the printer.</p> <hr/> <p>Command syntax: PLOt <mode></p> <p>where: <mode> = ALL or CURve</p> <p>ALL = Curve with readout data and graticule</p> <p>CUR = Curve only</p>

PStatus?

Group Miscellaneous

Purpose Queries the 371B for the status of the printer interface.

Header	Argument	Definition and Syntax
PStatus		Respond with the current status of the printer. Response syntax: PStatus <status> where: <status> = READY or BUSY and READY = idle mode BUSY = busy mode

RECall

Group Miscellaneous

Purpose Recalls a set of front-panel settings.

Header	Argument	Definition and Syntax
RECall	<NR1>	Recall the front-panel settings from a specified memory location. <hr/> Command syntax: RECall <index> where: <index> = 1 ... 80 (memory location)

SAVe

Group Miscellaneous

Purpose Saves the current set of front-panel settings.

Header	Argument	Definition and Syntax
SAVe	<NR1>	<p>Save the current front-panel settings in the specified memory location.</p> <hr/> <p>Command syntax: SAVe <index></p> <p>where: <index> = 1 80 (memory location)</p>

**Status and Event
Commands and Queries**

The Status and Event Reporting group sets and reports the status of service requests and operation complete service requests. A query is also included for the event code of the latest event.

The commands and queries in this group include:

EVEnt?

OPC

OPC?

RQS

RQS?

An alphabetical listing of all command and query headers is given in the “Command Index”.

A cross reference for front-panel controls and corresponding GPIB commands and queries is also given in Table 4–6.

EVEnt?

Group Status and Event

Purpose Queries the 371B for the event code of the most recent event.

Header	Argument	Definition and Syntax
EVEnt?		Return the event code for the most recent event. Response syntax: EVENT <code> where: <code> = A three-digit event code. Refer to "Event Codes" later in this chapter for a list of event codes and definitions.

OPC

Group Status and Event

Purpose Sets the status of operation complete service request.

Header	Argument	Definition and Syntax
OPC	ON OFF	<p>Enable or disable assertion of operation complete service request upon completion of an operation, a change in the circuit breaker status, or a change in the status of the interlock system.</p> <hr/> <p>Command syntax: OPC <status></p> <p>where: <status> = ON or OFF</p>

OPC?

Group Status and Event

Purpose Queries the 371B for the status of the operation complete service request (OPC).

Header	Argument	Definition and Syntax
OPC?		Respond with the current status of the operation complete service request feature. <hr/> Response syntax: OPC <status> where: <status> = ON for enabled or OFF for disabled.

RQS

Group Status and Event

Purpose Sets the status of Service Requests.

Header	Argument	Definition and Syntax
RQS	ON OFF	Enabled or disabled assertion of service requests (RQSs). Command syntax: RQS <status> where: <status> = ON or OFF

RQS?

Group Status and Event

Purpose Queries the 371B for the status of service request.

Header	Argument	Definition and Syntax
RQS?		Respond with the current status of service request. <hr/> Response syntax: RQS? <status> where: <status> = ON for enabled or OFF for disabled.

**Step Generator
Commands and Queries**

The Step Generator command and query group sets and asks for the status of the step generator settings.

The commands and queries in this group include:

STPgen
STPgen?

An alphabetical listing of all command and query headers is given in the “Command Index”.

A cross reference for front-panel controls and corresponding GPIB commands and queries is also given in Table 4-6.

STPgen

Group Step Generator

Purpose Sets the step generator source, step size, number of steps, polarity, step multiplication, and offset.

Header	Argument	Linked Argument	Definition and Syntax
STPgen	OUT	ON OFF	Enable or disabled the step generator output. Command syntax: STPgen OUT:<mode> where: <mode> = ON or OFF
	CURrent: VOLtage:	<NR3> <NR3>	Set the step generator to provide current or voltage steps, and set the step size in amperes or volts. Command syntax: STPgen <source>:<val> where: <source> = CUR or VOL <val> = 1.0E-6 through 2.0E-3 when Peak Power Watts is 30 W/3 W/0.3 W/0.03 W and 1.0E-3 to 2.0E+0 when Peak Power Watts is 3 kW/300 W for current step size (amp/div). <val> = 2.0E-1 through 5.0E+0 in an 1-2-5 sequence for voltage step size (volts/div). Example: STPgen CURrent: 1.0E-3
	NUMber	<NR1>	Set the number of steps to be generated. Command syntax: STPgen NUMber :<val> where: <val> = 0, 1, 2, ..., 10 (0 through 5 when Step/Offset Amplitude is 5 V or 2 A).
	INVert:	ON OFF	Set the step generator polarity. Command syntax: STPgen INVert :<mode> where: <mode> = ON or OFF
	OFFset:	<NR2>	Set the offset of the step generator. Command syntax: STPgen OFFset: <val> where: <val> = 0.00 or 0.01 ... 9.99 or 10.00 (0.00 through 5.00 when Step/Offset Amplitude is 5 V or 2 A)

STPgen?

Group Step Generator

Purpose Queries the 371B for the current settings of the step generator source, number of steps, step size, polarity, step multiplication, and offset.

Header	Argument	Definition and Syntax
STPgen?		<p>Respond with the step generator source, amps/step or volt/step, number of steps, offset, polarity, multiplier mode, or output mode.</p> <hr/> <p>Response syntax: STPGEN:<output>, NUMBER:<num>, OFFSET:<offset>, INVERT:<invert>, MULT:<mult>,<type:size></p> <p>where:</p> <p><output> = ON or OFF <num> = number of steps, 0 - 10 <offset> = offset value multiplier <invert> = invert mode status, ON or OFF <mult> = step multi status, ON or OFF <type:size> = CURRENT:size (A/step) or VOLTAGE:size (V/step)</p>

**Waveform Transfer
Commands and Queries**

The Waveform Transfer group allows curve or preamble data (or both) to be stored in, or recalled from, mass storage. There is also a command to set the number of curve data points stored and a related query to determine the length of a previously defined waveform.

The commands and queries in this group include:

CURve
CURve?
WAVfrm?
WFMpre
WFMpre?
WFMpre NR.PT
WFMpre? NR.PT

An alphabetical listing of all command and query headers is given in the “Command Index”.

A cross reference for front-panel controls and corresponding GPIB commands and queries is also given in Table 4–6.

CURve

Group Waveform Transfer

Purpose Store a curve.

Header	Argument	Definition and Syntax
CURve	<string>	<p>Load the curve into the specified memory location.</p> <hr/> <p>Command syntax: CURve <string></p> <p>where: <string> = CURVID:<curveid>,%<binary data></p> <p>where: <curveid> = "INDEX <index>"</p> <p><binary data> = <count><first point> ... <last point><checksum></p> <p>where: <index> = 1 80 for memory storage location.</p> <p><count> = two bytes indicating the number of data points plus one.</p> <p><point> = two bytes indicating the X coordinate and two bytes indicating Y coordinate for a point (00 through FF).</p> <p><checksum> = One byte, the two's complement of the modulo-256 sum of the preceding binary data.</p>

CURve?

Group Waveform Transfer

Purpose Queries the 371B for curve data.

Header	Argument	Definition and Syntax
CURve?		<p>Respond with the curve data for the view curve when in view mode, and with the curve data for the current display when in store mode.</p> <hr/> <p>Response syntax: CURVE CURVEID <curveid>,%<binary data></p> <p>where: <curveid> = "INDEX <index>"</p> <p><binary data> = <count><first point> ... <last point><checksum></p> <p>where: <index> = 1 80 for memory storage location.</p> <p><count> = two bytes indicating the number of data points plus one.</p> <p><point> = two bytes indicating the X coordinate and two bytes indicating Y coordinate for a point (00 through FF).</p> <p><checksum> = One byte, the two's complement of the modulo-256 sum of the preceding binary data.</p>

WAVfrm?

Group Waveform Transfer

Purpose Queries the 371B for the curve and preamble data. This query function as a combination of the **WFMpre?** and **CURve?** queries.

Header	Argument	Definition and Syntax
WAVfrm?		<p>Respond with both preamble and curve data for the current waveform.</p> <p>See the discussions for WFMpre? and CURve? for details.</p> <p>The preamble and curve data are separated by a semicolon.</p>

WFMpre

Group Waveform Transfer

Purpose Store the preamble data for the currently displayed waveform into a specified memory location.

Header	Argument	Definition and Syntax
WFMpre	<string>	<p> Load the waveform preamble into the location indicated by the current content of the memory index display. </p> <hr/> <p> Command syntax: WFMpre <string> </p> <p> where: <string> = WFD:<wfid>,ENCDG:BIN,NR.PT:<point>,PT.FMT:XY,XMULT:<x multi>,XZERO:0,XOFF:<x off>,XUNIT:V,YMULT:<y multi>,YZERO:YOFF:<y off>,YUNIT:A,BYT/NR:2,BN.FMT:RP,BIT/NR:10,CRVCHK:CHKSM0,LN.FMT:<format> </p> <p> where <wfid> = ''INDEX<num>/VERT<amp>/HORIZ<volt>/STEP<step>OFFSET<offset>/BGM<para>/VCE<percent>?TEXT<txt>/HSNS<mode>'' </p> <p> where: <num> = display address: 0 for CRT, 1 ... 80 for memory location, <NR1> </p> <p> <amp> = sensitivity, A/div <NR3> </p> <p> <volt> = sensitivity, V/div <NR3> </p> <p> <step> = step amplitude V or A/step <NR3> </p> <p> <offset> = step offset, V or A </p> <p> <para> = β or gm </p> <p> <percent> = collector supply VARIABLE setting, % </p> <p> <txt> = readout of text area </p> <p> <mode> = horizontal source, V_{CE} or V_{BE} </p> <p> <point> = number of points in the curve (1 thru 1024) </p> <p> <x multi> = horizontal scale factor, <NR3> </p> <p> <x off> = horizontal offset, <NR1> </p> <p> <y multi> = vertical scale factor, <NR3> </p> <p> <y off> = vertical offset, <NR1> </p> <p> <format> = VECTOR, DOT, or SWEEP <cnt> </p>

WFMpre?

Group Waveform Transfer

Purpose Queries the 371B for the preamble data stored in a specified memory location.

Header	Argument	Definition and Syntax
WFMpre?		<p>Respond with the waveform preamble from the specified memory location.</p> <p>Response syntax: WFD:<wfid>,ENCDG:BIN,NR.PT:<point>,PT.FMT:XY, XMULT:<x multi>,XZERO:0,XOFF:<x off>,XUNIT:V, YMULT:<y multi>,YZERO:YOFF:<y off>,YUNIT:A,BYT/NR:2, BN.FMT:RP,BIT/NR:10,CRVCHK:CHKSM0,LN.FMT:<format></p> <p>where <wfid> = "INDEX<num>/VERT<amp>/HORIZ<volt>/ STEP<step>OFFSET<offset>/BGM<para>/ VCE<percent>?TEXT<txt>/HSNS<mode>"</p> <p>where: <num> = display address: 0 for CRT, 1 ... 80 for memory location, <NR1></p> <p><amp> = sensitivity, A/div <NR3></p> <p><volt> = sensitivity, V/div <NR3></p> <p><step> = step amplitude V or A/step <NR3></p> <p><offset> = step offset, V or A</p> <p><para> = β or gm</p> <p><percent> = collector supply VARIABLE setting, %</p> <p><txt> = readout of text area</p> <p><mode> = horizontal source, V_{CE} or V_{BE}</p> <p><point> = number of points in the curve (1 thru 1024)</p> <p><x multi> = horizontal scale factor, <NR3></p> <p><x off> = horizontal offset, <NR1></p> <p><y multi> = vertical scale factor, <NR3></p> <p><y off> = vertical offset, <NR1></p> <p><format> = VECTOR, DOT, or SWEEP <cnt></p>

WFMpre NR.PT

Group Waveform Transfer

Purpose Sets the length of the waveform.

Header	Argument	Linked Argument	Definition and Syntax
WFMpre	NR.PT:	<NR1>	Set the number of points input for the CURve command. Command syntax: WFMpre NR.PT:<points> where: <points> = 1 1024

WFMpre? NR.PT

Group Waveform Transfer

Purpose Queries the 371B for the length of a waveform previously defined with the **WFMpre NR.PT** command.

Header	Argument	Definition and Syntax
WFMpre?	NR.PT:	Respond with the NR.PT waveform preamble data. Response syntax: WFMPRE NR.PT:<points> where: <points> = 1 1024

Service Requests

The standard GPIB status and error reporting system used by the 371B sends intercept messages to the bus controlled by asserting the service request (SRQ) line on the bus. This SRQ message indicates that either an error or a change in status has occurred.

Handling Service Requests

To service an interrupt, the controller polls the instruments on the bus. The instrument asserting SRQ (the 371B in this case) returns a status byte indicating the category of the event causing the service request. Each service request is automatically cleared after responding to the poll. If there is more than one event to report, the instrument reasserts SRQ until all pending events have been reported. (A complete list of status bytes that can occur is found in Table 4–9.)

After polling the 371B for the status byte, the controller can obtain more detailed information about the service request event by sending the `EVENT?` query. The response to an `EVENT?` query is an event code, which is an `<NR1>` number corresponding to certain conditions that may have occurred. Table 4–10 lists the event codes returned by the 371B.

The status byte and event code can be accessed later if they are not read and cleared immediately. In the case of multiple events, only the latest status byte and the one pending are saved. Event codes, however, are kept in a 1—deep, Later-In-First-Out (LIFO) buffer for later recall.

The following program segments demonstrate how service requests are handled along with the corresponding status byte and event code. The status byte and event code are printed on the controller display to track instrument status.

IBM PC: (This is for use with the auto-serial-poll flag disabled in the National instruments GPIB card configuration file.)

```
800          REM *** SIMPLE SRQ HANDLER FOR 371B ***
810          CALL IBRSP (BD%, SPR%)
820          WRT$="EVENT"
830          CALL IBWRT (BD%, WRT$)
840          RD$=SPACE$ (100)
850          CALL IBRD (BD$, RD$)
860          PRINT "STATUS=";SPR%, 'EVENT=";RD$
```

Hewlett Packard 200/300 Series:

```

800      REM *** SIMPLE SRQ HANDLER FOR 371B ***
810      STB=SPOLL (DEV)          ! poll device
                                       previously
                                       defined.

820      OUTPUT DEV;"EVENT?",END
! Send "EVENT?"                                query

830      ENTER DEV;EVENT$
840      PRINT "STATUS=";STB;" EVENT=";EVENT$
                                       ! Show status and
                                       event.

```

Masking Service Requests

The operation completes service request (OPC SRQ) is a special type of service request to communicate that certain instrument processes have finished. These OPC service requests indicate that the 371B has finished one operation and ready to proceed to the next.

It may not always be desirable to interrupt the program with service request or OPC service requests. Either type of service request can be masked so that the 371B will not assert them until the mask is removed. This masking is accomplished with the **RQS** and **OPC** commands.

RQS ON enables the 371B to assert an SRQ when it has an event to report. If this feature is turned off (**RQS OFF**), up to 10 events are still accumulated and can be retrieved with successive **EVENT?** queries.

OPC ON enables the 371B to assert an **OPC SRQ** upon completion of an operation, a change in circuit breaker status, or a change in the status of the interlock system.

NOTE. *The response to RQS? and OPC? queries only indicates whether the function is enable (ON) or disable (OFF). They do not give any status or event information.*

Status Bytes

Table 4-9: Status Byte Responses

8 7 6 5 4 3 2 1	Decimal	Condition
0 0 0 0 0 0 0 0	0	No status to report. This status byte is set when there are no events or device-dependent events to report.
0 1 0 0 0 0 0 1	65	Power on. This occurs when the power is turned on, after having been off.
0 1 0 0 0 0 1 1	67	User request. This status byte occurs when the front-panel RQS key is pressed.
0 1 1 0 0 0 0 1	97	Command error. This status byte is set when a message cannot be parsed or recognized.
0 1 1 0 0 0 1 0	98	Execution error. This status byte is set when a message is parsed and is recognized, but cannot be executed. For example, if the floppy disk is not in place when a SAVE 20 command is received, the 371B registers an execution error.
0 1 0 0 0 0 1 1	99	Internal error. This status byte indicates that the 371B microcomputer has discovered a malfunction that could cause the instrument to operate incorrectly.
1 1 0 0 0 0 0 0	192	Device-dependent event. This status byte is set when there is an event specific to the 371B. Primarily, these events signify the completion of a process, such as "PRINTER OUTPUT COMPLETE."

Bit 1 through 4 are the four-bit status code;

Bit 6 indicates abnormal (1), normal (0) condition;

Bit 7 indicates SRQ asserted (depends on RQS command)

Event Codes Table 4–10 describes the meaning of the status bytes and event codes.

Table 4–10: Status Byte and Event Code

Status byte	Event code	Meaning
System Event		
0	0	No error
65	401	Power on
66	402	Measure signal operation complete (mask OPC)
67	403	User request (FAST + SINGLE button)
Command Error		
97	101	Command header error
97	102	Command argument count error
97	103	Command argument error
97	106	Command syntax error
97	108	Waveform checksum error
97	109	Byte count error
Execution Error		
98	201	Command not executable in local mode
98	203	Buffer overflow
98	204	Setting conflicts
98	205	Argument out of range
98	272	Collector Supply Breaker Unmatch
98	273	NR, PT and byte count unmatch
98	274	No waveform available
98	275	Step Gen setting in Step Gen. Disabled mode
98	276	Format error
98	277	NVM data empty
98	278	NVM read/write error
98	279	Checksum error
98	280	FD data empty
98	281	FD not ready
98	282	Write protect
98	283	Disk full
98	284	Invalid data
98	285	FD fault

Table 4-10: Status Byte and Event Code (Cont.)

Status byte	Event code	Meaning
98	286	FD read error
98	287	FD write error
98	288	FD seek error
Internal Error		
99	353	Phase lock system failed
99	354	Collector supply overheated
99	357	Collector supply fuse blow
99	350	Outputs protected
99	358	Interlock system failed
Device-dependent Event		
192	750	Single measurement complete (at OPC ON)
192	751	Sweep measurement complete (at OPC ON)
192	752	Printer output complete
192	753	Collector Supply recovered
192	754	Collector Supply breaker changed (at OPC ON)
192	755	Interlock system changed (at OPC ON)
192	756	Format complete (at OPC ON)
192	757	Copy complete (at OPC ON)
192	758	NVM erase complete (at OPC ON)



Appendices

Appendix A: Specification

This appendix specifies the electrical, mechanical, and environment performance requirements of the 371B.

Performance Conditions

The following electrical and environmental characteristics are valid for instruments operated at ambient temperatures from +10°C to +40°C after an initial warmup period of 20 minutes, when previously calibrated at a temperature from +20 to +30°C.

The performance of all stimulus outputs (collector high current, collector high voltage, step generator current, step generator voltage) should be verified on the test fixture unit.

To prevent temperature rising of internal ambient temperature and external GND pin at the maximum power condition, continuous setting should be limited.

Intermittent use at above condition is:
 4 min. Operating
 11 min. Non-operating

Table A-1: Collector Supply Electrical Specification

Characteristic	Performance Requirement	Supplemental Information
Collector Supply Polarity		Selected by the collector supply POLARITY button.
NPN +	Positive pulse for 300 W/ 3 kW peak power watts. Positive rectified sine-square wave for 30 W/ 3 W/ 300 mW/ 30 mW peak power watts.	Applies positive pulse to the collector terminal. Measures collector/Drain current. Applies positive full-wave rectified square sine wave to the collector terminal. Measure collector/Drain current.
PNP -	Negative pulse for 300 W/3 kW peak power watts. Negative rectified sine-square wave for 30 W/ 3 W/ 300 mW/ 30 mW peak power watts.	Applies negative pulse to the collector terminal. Measures collector/Drain current. Applies negative full-wave rectified square sine wave to the collector terminal. Measure collector/Drain current.
Peak Power Watts Range	3 kW 300 W 30 W 3 W 300 mW 30 mW	Selected by the PEAK POWER WATTS buttons, but 300 mW or 30 mW setting is selected by the 30 W or 3 W button with the SHIFT button. Derived from nominal peak open circuit collector voltage and nominal series resistance value.

Table A-1: Collector Supply Electrical Specification (Cont.)

Characteristic	Performance Requirement	Supplemental Information
Collector Peak Current		With a shorted load in the test fixture unit.
3 kW range	400 A	Pulsed collector supply
300 W range	40 A	Pulsed collector supply
30 W range	40 mA, -20 %, +20 %	Sine wave collector supply
3 W/ 300 mW range	4 mA, -20 %, +20 %	Sine wave collector supply
30 mW range	0.4 mA, -20 %, +20 %	Sine wave collector supply
Maximum Peak Voltage	Peak open circuit voltage	At 100 % VARIABLE COLLECTOR SUPPLY.
3 kW range	30 V, +10 %, -5 %	Pulsed collector supply
300 W range	30 V, +10 %, -5 %	Pulsed collector supply
30 W range	3 kV, +10 %, -0 %	Rectified sine-wave collector supply
3 W range	3 kV, +10 %, -0 %	Rectified sine-wave collector supply
300 mW range	300 V, +15 %, -0 %	Rectified sine-wave collector supply
30 mW range	300 V, +15 %, -0 %	Rectified sine-wave collector supply
Variable Collector Supply	0 % to 100.0 %	% of maximum peak voltage value is displayed on the CRT readout area. Provides uncalibrated variable control of collector supply amplitude from 0 to 100 % in 0.1 % increments.
Looping Compensation	Valid for High Voltage mode	Cancels stray capacitance from collector terminal and ground at Collector Peak Power Watts 30 W/ 3 W and 300 mW/ 30 mW.
Range	Maximum 100 pF	
Vertical Projection	Within +10 μ A, -20 μ A	At open circuit connecting with Test Fixture box at Collector Peak Power Watt 30 W.
Tan Delta	Within \pm 2.5 μ A at 3 kV	
Sweep Start Voltage	Less than +10 %, -10 % of peak volt.	Valid for High Voltage mode.
OUTPUTS Indicator		Indicates all outputs (COLLECTOR SUPPLY, STEP GENERATOR output terminal) enabled/disabled mode.
CIRCUIT BREAKER	High Current Circuit Breaker is disabled by rush current.	Interrupts COLLECTOR SUPPLY HIGH CURRENT/ HIGH VOLTAGE outputs separately.

Table A-1: Collector Supply Electrical Specification (Cont.)

Characteristic	Performance Requirement	Supplemental Information
Pulsed Collector Supply	Pulse amplitude is controlled by VARIABLE COLLECTOR SUPPLY.	At High Current mode (Peak Power Watts 3 kW/ 300 W)
Repetition Rate	One-fourth (.25 X) line frequency	At 3 kW peak power watts.
	One-half (.5 X) line frequency	At 300 W peak power watts.
Pulse Width (Half amplitude)	250 μ s +10 %, -10 %	More than 30 % of the collector supply VARIABLE at open circuit.
	150 μ s to 250 μ s	5 % to 30 % of the collector supply VARIABLE at open circuit.
Rise time/ Fall Time	40 μ s to 120 μ s	With collector supply VARIABLE at 50 %. COLLECTOR SUPPLY at Open circuit. <i>Note: To prevent False Triggering on Thyristor, di/dt is limited less than 10 A/μs.</i>
Overshoot/ Undershoot	Less than 5 % of total output	More than 5 % of VARIABLE COLLECTOR SUPPLY at Open circuit.

Table A-2: Step Generator

Characteristics	Performance Requirements	Supplemental Information
Incremental Accuracy (Current or Voltage Steps including Offset)		Check DMM Reading.
	Within 2 % between any two steps.	Without STEP MULTI .1X
	Within 5 % between any two steps.	With STEP MULTI .1X
Absolute Accuracy (Current or Voltage Steps including Offset)	Within 2 % of total output + 3 % of Step range + 10 nA or 2 mV.	Without STEP MULTI .1X
	Within 4 % of total output + 5 % of Step range + 10 nA or 2 mV.	With STEP MULTI .1X
Offset Control Range	Variable 0 to 10 times STEP/OFFSET AMPLITUDE setting. However, 0 to 5 times when STEP/OFFSET AMPLITUDE is 5 V or 2 A.	Same polarity as step signal. Control resolution is 1 %.
Number of Steps	0 to 10. However, 0 to 5 when STEP/OFFSET AMPLITUDE setting is 5 V or 2 A.	
Step Polarity	Positive, Negative	Corresponds to the collector supply POLARITY when step generator INVERT is disabled.

Table A-2: Step Generator (Cont.)

Characteristics	Performance Requirements	Supplemental Information
Step Rate		
3 kW peak power watts	One-fourth (.25 X) the line frequency	
300 W peak power watts	One-half (.5 X) the line frequency	
30 W, 3 W, 300 mW, 30 mW peak power watts	Twice (2 X) the line frequency	
Current Mode		Provides current staircase or pulsed current step.
Amplitude Range		Selected by STEP/OFFSET AMPLITUDE SWITCH.
Normal Step	1 μ A to 2 mA in 1-2-5 sequence.	COLLECTOR SUPPLY HIGH VOLTAGE MODE (30 W/ 3 W and 300 mW/ 30 mW)
Pulsed Step	1 mA to 2 A in 1-2-5 sequence.	COLLECTOR SUPPLY HIGH CURRENT MODE (3 kW/ 300 W)
Maximum Current	20 times step amplitude, except 10 times STEP/OFFSET AMPLITUDE when control is set to 2 A per step.	
Maximum Voltage	12 V, +30 %, -30 %	Accuracy: At least 5 V.
Ripple plus Noise	Within 1 % of STEP AMPLITUDE + 10 nA	Check by Oscilloscope with 20 MHz bandwidth.
Maximum Inductive Load	1 μ H	
Maximum Resistive Load	500 Ω	At 1 mA/step without STEP MULTI .1X Accuracy: At least 5 V.
Maximum Capacitive Load	1000 pF	
Pulsed Current Step	Valid for STEP GENERATOR Current mode.	When Pulsed Collector Supply (PEAK POWER WATTS 3 kW/ 300 W) is selected, STEP CURRENT becomes pulsed step automatically.
Pulse Width	500 μ s +10 %, -10 %	With 1 k Ω load, 1 mA/step with STEP MULTI .1X off.
Rise Time ¹	Less than 40 μ s	With 1 k Ω load, 1 mA/step with STEP MULTI .1X off.
Fall Time ¹	Less than 40 μ s	With 1 k Ω load, 1 mA/step with STEP MULTI .1X off.
Overshoot/ Undershoot	Less than 10 %	With 1 k Ω load, 1 mA/step and zero Variable Collector Supply.

Table A-2: Step Generator (Cont.)

Characteristics	Performance Requirements	Supplemental Information
Voltage Mode		Provides normal voltage staircase step every time.
Step Amplitude Range	200 mV to 5 V in 1-2-5 sequence.	Selected by STEP/OFFSET AMPLITUDE SWITCH.
Short Circuit Current Limiting	100 mA + 50 %, -20 %	
Maximum Voltage	10 times STEP AMPLITUDE	With 5 V STEP AMPLITUDE setting.
	20 times STEP AMPLITUDE	Except 5 V STEP AMPLITUDE setting.
Ripple plus Noise	Within 1 % of STEP AMPLITUDE + 10 mV	Check by Oscilloscope with 20 MHz bandwidth.

- ¹ **Pulsed Current Response for high DUT resistance. The specific degradation occurs when the DUT resistance (R_{dut}) is greater than Current sense resistor (R_{sense}) of the amplifier by 10 times.**

The time constants for the rise time and fall time above is given as $T_{dut} = T_0 * (1 + R_{dut}/R_{sense})$ where T_{dut} is the time constants for DUT with R_{dut} resistance and T_0 is the time constants for the DUT with zero resistance.

The Current sense resistors are listed as following table.

R _{sense}	STEP AMPLITUDE (with STEP MULTI .1X on) setting
0.1 Ω	2 A and 1 A STEP (200 mA and 100 mA STEP)
1.0 Ω	500, 200 and 100 mA STEP (50, 20 and 10 mA STEP)
10 Ω	50, 20 and 10 mA STEP (5, 2 and 1 mA STEP)
100 Ω	5, 2 and 1 mA STEP (500, 200 and 100 μA STEP)
1.0 kΩ	500, 200 and 100 μA STEP (50, 20 and 10 μA STEP)
10 kΩ	50, 20 and 10 μA STEP (5, 2 and 1 μA STEP)
100 kΩ	5, 2 and 1 μA STEP (500, 200 and 100 nA STEP)

Table A-3: Vertical Deflection System

Characteristic	Performance Requirement	Supplemental Information
Collector Current (Ic) Range		Varies in Collector Supply Peak Power Watts
3 kW peak power watts	1 A/DIV to 50 A/DIV	
300 W peak power watts	500 mA/DIV to 5 A/DIV	
30 W peak power watts	100 μ A/DIV to 5 mA/DIV	
3 W peak power watts	10 μ A/DIV to 500 μ A/DIV	
0.3 W peak power watts	10 μ A/DIV to 500 μ A/DIV	
0.03 W peak power watts	1 μ A/DIV to 50 μ A/DIV	
Collector Current (Ic) Accuracy	Within 0.1 div of the Vertical graticule lines.	
Collector Current (Ic) Cursor Accuracy	Within 1.5 % of readout + 0.1 DIV of the CURRENT/DIV setting.	In Store mode (use the DOT CURSOR)

Table A-4: Horizontal Deflection System

Characteristic	Performance Requirement	Supplemental Information
Collector Supply Volts (Vce) Range		At Collector Peak Power Watts 3 kW/ 300 W
3 kW, 300 W peak power watts	100 mVdiv to 5 V/div in a 1-2-5 sequence	
30 W, 3 W peak power watts	50 Vdiv to 500 V/div in a 1-2-5 sequence	
300 mW, 30 mW peak power watts	5 Vdiv to 50 V/div in a 1-2-5 sequence	
Step Generator Volts (Vbe) Range	100 mV/div to 5 V/div in a 1-2-5 sequence	
Step Generator Volts (Vbe) Accuracy	Within 0.1 div of Horizontal graticules.	
Step Generator Volts (Vbe) Cursor Accuracy	Within 1.5 % of the readout + 0.1 division of HORIZONTAL VOLTS/DIV setting.	
	At 100 mV/DIV COLLECTOR: Within 5 % of the readout + 0.2 division of the HORIZONTAL VOLTS/DIV setting.	

Table A-5: Digital Storage Acquisition

Characteristic	Performance Requirement	Supplemental Information
A/D Converter		
Resolution	10 bits for 1024 division, 100 points per one division.	
Tolerance	Within ± 2 count	
Max Data Point	1024	
Max Sample Rate	1024 times Line frequency	
Min Sample Rate	1/8 times Line frequency	

Table A-6: CRT and Readout

Characteristic	Performance Requirement	Supplemental Information
CRT		
Type	Electrostatic deflection	
Phosphor	P31	
Accelerating Potential	Typical 12 kV	
Screen Size	178 mm (7 in) diagonal, internal graticule and scale factor.	
Total addressable Pixels	1000 X 1000 for Curve Display	
Geometry	1/2 minor division or less of keystone.	
Resolution	At least 10 line/Div	
Spot Size	Less than 0.95 mm (center)	
Orthogonality	90 °, Within 0.6 °	
Trace Rotation	At least ± 3 °	
Readout	On-screen display	
VERT/DIV	Collector Supply Current deflection factor (Ic/DIV)	
Peak Power Watts		
3 kW	1 A/DIV to 50 A/DIV	
300 W	500 mA/DIV to 5 A/DIV	
30 W	100 μ A/DIV to 5 mA/DIV	
3 W	10 μ A/DIV to 500 μ A/DIV	
0.3 W	10 μ A/DIV to 500 μ A/DIV	
0.03 W	1 μ A/DIV to 50 μ A/DIV	
HORIZ/DIV	Collector Supply Voltage (Vce) or Step Generator Voltage (Vbe) deflection factor.	
Peak Power Watts	Vce	
3 kW, 300 W	100 mV/DIV to 5 V/DIV	
30 W, 3 W	50 V/DIV to 500 V/DIV	

Table A-7: Power Requirements

Characteristic	Description
Power Connection	This instrument is designed for operation from power source with its natural at or near ground (earth) potential. It is not intended for two phase of multi-phase system, or across legs of single-phase, three wire system. It is provided with a three-wire power code with three terminal polarized plug for connection to the power source. Third wire directly connected to instrument frame, and is intended to ground the instrument to protect operating personnel, as recommended by national and international safety codes.

Table A-8: Power Source

Characteristic	Description		
Line Voltage Range	CAT II		
Nominal	Range	Line Fuse	Collector Fuse
240 V	High 216 V to 250 V	250 V, 1 A, Slow	250 V, 2 A, Slow
200 V	Low 180 V to 220 V	250 V, 1 A, Slow	250 V, 2 A, Slow
120 V	High 108 V to 132 V	250 V, 2 A, Slow	250 V, 4 A, Slow
100 V	Low 90 V to 110 V	250 V, 2 A, Slow	250 V, 4 A, Slow
Line Frequency	48.0 Hz to 63.0 Hz		
Maximum Power Dissipation (Fully Loaded)	400 W max. Maximum line current is 4.5 Arms at 50 Hz, 90 V line, with 5 % clipping.		

Table A-9: Physical Specification

Characteristic	Description
Weight	Approx. 36 kg (79.3 lb)
Height	326 mm (12.8 in) with feet 310 mm (12.2 in) without feet
Width	429 mm (16.9 in)
Depth	638 mm (25.1 in)

Table A-10: Surge Current

Characteristic	Description
Surge Current	80 A peak (25 °C) for ≤ 5 line cycles, after product has been turned off for at least 30 s.

Table A-11: Cooling Clearance

Characteristic	Description
Clearance	
Top and Bottom	0 cm
Side	5 cm (2 in)
Rear	5 cm (2 in)

Table A-12: Environmental Specification

Characteristic	Description
Temperature	
Operating	+10°C to +40°C
Nom-Operating	-20°C to +60°C
Temperature gradient	
Operating	≤ 15°C per hour (no condensation)
Non-operating	≤ 15°C per hour (no condensation)
Altitude	
Operating	Up to 3.0 km (10000 ft)
Non-Operating	Up to 15 km (50000 ft) Maximum operating temperature decreases 1°C each 300 m (1000 ft) above 1.5 km (5000 ft)
Relative Humidity	
Operating	20 % to 80 % (no condensation) Maximum wet bulb temperature shall be 29.4°C.
Storage	5 % to 90 % (no condensation) Maximum wet bulb temperature shall be 40.0°C.
Vibration	
Operating	2.352 m/s ² (0.24 G _{rms}), 5 Hz to 500 Hz
Non-Operating	21.756 m/s ² (2.22 G _{rms}), 5 Hz to 500 Hz
Shock (non-operating)	196 m/s ² (20 G), half-sine, 11 ms duration. Three shocks per axis in each direction (18 shocks total)
Bench handling	
Operating	Drop from 10 cm (4 in) tilt, or 45 ° which ever less (Tilt not to balance to point.)
Packaged transportation drop	Meets the limits of the National Safe Transit Association test procedure 1A-B-2; 10 drops of 610mm (24 in).
Packaged transportation vibration	Meets the limits of the National Safe Transit Association test procedure 1A-B-1 ;excursion of 2.5mm (1 in) p-p at 4.63 Hz (1 .1 G) for 60 minutes.

Table A-13: Certifications and Compliances

Category	Standards or description
EC Declaration of Conformity – EMC	Meets intent of Directive 89/336/EEC, amended by 93/68/EEC; EN 61326-1: 1997 Product Family Standard for Electrical Equipment for Measurement, Control, and Laboratory Use-EMC Requirement.
Emissions	EN 55011 Class A Radiated and Conducted Emissions EN 61000-3-2 Power Line Harmonic EN 61000-3-3 Line Voltage Alteration and Flicker
Immunity	EN 61000-4-2 Electrostatic Discharge Immunity EN 61000-4-3 Radiated RF Electromagnetic Field Immunity Note: The output level of Step Generator may vary in this test. EN 61000-4-4 Electrical Fast Transient/Burst Immunity Note: This test may cause the oscillation of EUT. EN 61000-4-5 Surge Immunity EN 61000-4-6 Conducted Disturbance induced by RF Field Immunity EN 61000-4-8 Power Frequency Electromagnetic Field Immunity EN 61000-4-11 Voltage Drop, Short Interruptions and Voltage Variations Immunity Note: The output of Collector Supply is disabled after this test.
Australia/New Zealand Declaration of Conformity – EMC	Complies with EMC provision of Radio Communications Act per the following standard: Industrial, Scientific, and Medical Equipment: 1992
Safety	UL3111-1 CAN/CSA C22.2 NO. 1010.1
Self-Declaration	EN 61010-1 with second amendment
Installation Category	Power input – Installation Category II (as defined in IEC 61010-1, Annex J)
Pollution Degree	Pollution degree 2 (as defined in IEC 61010-1)

Table A-14: Installation category and Pollution degree Descriptions

Characteristics	Description	
Installation category	Terminals on this product may have different installation category designations. The installation categories are:	
	<i>Category</i>	<i>Descriptions</i>
	CAT III	Distribution-level mains (usually permanently connected). Equipment at this level is typically in a fixed industrial location
	CAT II	Local-level mains (wall sockets). Equipment at this level includes appliances, portable tools, and similar products. Equipment is usually cord-connected
	CAT I	Secondary (signal level) or battery operated circuits of electronic equipment
Pollution degree	A measure of the contaminants that could occur in the environment around and within a product. Typically the internal environment inside a product is considered to be the same as the external. Products should be used only in the environment for which they are rated.	
	<i>Category</i>	<i>Descriptions</i>
	Pollution Degree 1	No pollution or only dry, nonconductive pollution occurs. Products in this category are generally encapsulated, hermetically sealed, or located in clean rooms.
	Pollution Degree 2	Normally only dry, nonconductive pollution occurs. Occasionally a temporary conductivity that is caused by condensation must be expected. This location is a typical office/home environment. Temporary condensation occurs only when the product is out of service.
	Pollution Degree 3	Conductive pollution, or dry, nonconductive pollution that becomes conductive due to condensation. These are sheltered locations where neither temperature nor humidity is controlled. The area is protected from direct sunshine, rain, or direct wind.
	Pollution Degree 4	Pollution that generates persistent conductivity through conductive dust, rain, or snow. Typical outdoor locations.

Functional Specification

Table A-15: Text Display

Characteristic	Performance Requirement	Supplemental Information
Alphanumeric character set (1)	SP, !, ..., A, B, ..., 0, 1, ..., 9, /, ... , a, b, ..., y, Z, ... "u" is recognized as micro.	GPIB accessible with the TEXT command.
Alphanumeric character set (2)	(space), A, B, ... , Y, Z, (space), m, u, n, p, . , 0, 1, ..., 9, -, /, *, (,), = "u" is recognized as micro.	Accessible with the Position Control buttons.
Maximum text strings	24 characters	
Character size	Approximately 3 mm height, 2 mm width.	

Interface Characteristics

GPIB Interface. The IEEE-488-1978 (GPIB) standard defines the GPIB interface functions and the allowed subsets of those functions.

Function	Implemented As
Source handshake	SH1
Acceptor Handshake	AH1
Talker	T6
Listener	L4
Service request	SR1
Remote Local	RL2
Parallel poll	PP0
Device Clear	DC1
Device trigger	DT0
Controller	C0

Appendix B: Options and Accessories

Options

This subsection describes the following options available with the 371B Programmable High Power Curve Tracer.

- Option 1R (Rack mounting)
- Option D1 (Test result report)
- Option A9 (No power cord supplied)

Option 1R 371B Programmable High Power Curve Tracer comes configured for installation in a 19-inch wide instrument rack.

Option D1 A calibration data test result report will be provided with the 371B Programmable High Power Curve Tracer when this option is specified.

Option A9 371B Programmable High Power Curve Tracer comes without the power cord.

Accessories

Standard Accessories

The 371B Programmable High Power Curve Tracer includes the standard accessories listed in Table B-1:

Table B-1: Standard accessories

Accessory	Part number
User Manual	070-A840-XX
Test Fixture	016-A328-00
Test Adapters	
In-line Adapter	A1002
TO-3/TO-66 Adapter	A1003
Wire Set (Wire set with Alligator clips)	012-1371-00
Fuse	
250 V, 1 A, slow-blow	159-0022-01
250 V, 2 A, slow-blow	159-0238-00
250 V, 4 A, slow-blow	159-0291-00
Power Cord	161-0066-00
Utility Software (FDD)	063-3341-XX

Optional Accessories

The following optional accessories, listed in Table B-2, are recommended for use with the instrument:

Table B-2: Optional accessories

Accessory	Part number
Service Manual	070-A843-00
Test Adapter	
Blank Adapter	A1001
Axial Adapter	A1005
GPIB Cable, 2m	012-0991-00
Rack Mount Kit	016-0930-00
Cart	K475

**Recommended
Accessories**

The following optional accessories, listed in Table B-3, are recommended for use with the instrument:

Table B-3: Recommended accessories

Accessory	Model number
Thermal Printer CBM, Thermal Printer (http://www.jcbm.co.jp)	iDP3240

Appendix C: Diagnostic Routines and Messages

This appendix explains the 371B diagnostic routines and lists the messages displayed on the error message area of the CRT when the 371B detects operation errors, I/O errors, or emergency errors.

Diagnostic Routines

The 371B has four diagnostic routines: two kinds of power-on diagnostic routines, a user initiated diagnostic routine, and GPIB diagnostic routine.

Power-on Diagnostic Routines

At power on, the 371B runs the Power On Diagnostic routine to execute the following tests:

- Boot ROM check
- System RAM check
- Flash ROM check
- Display RAM check
- Acquisition RAM check

After completing the Power-on Diagnostic routines, the 371B displays a “SELFTEST PASS” message at the error message area of the CRT and sets the initial front panel setup.

If the 371B power is turned on while the cursor SHIFT button is pressed , a more detailed Power-on Diagnostic routine occurs in the following order:

- Boot ROM check
- System RAM check
- Flash ROM check
- Display RAM check
- Acquisition RAM check
- LED check
- Display quality check

To exit this diagnostic routine, press the cursor SHIFT button.

Boot ROM Check. After confirming that the boot ROMs are without fault, the 371B diagnoses the boot ROMs by checksum. If a system ROM fatal error is found (such as misinsertion), the memory index display alternately blinks 0 and 1.

If a checksum error is found, the appropriate error message is displayed in the CRT error message area. The message format follows:

ROM 000X

The 371B does not advance to the next routine.

System RAM Check. The 371B checks the system RAM by read/write operation. When a system RAM fatal error is found (such as bus shorted), the memory index display alternately blinks 0 and 2, and the 371B does not advance to the next routine.

Flash ROM Check. The 371B checks the Flash ROM by checksum. When a Flash ROM fatal error is found (such as bus shorted), the memory index display alternately blinks 0 and 5, and the 371B does not advance to the next routine.

Display RAM Check. The 371B checks the Display RAM by read/write operation. When a read/write error is found (such as bus shorted), the memory index display alternately blinks 0 and 3, and the 371B does not advance to the next routine.

Acquisition RAM Check. The 371B checks the Acquisition RAM by a read/write operation. When a read/write error is found (such as bus shorted), the memory index display alternately blinks 0 and 4, and the 371B does not advance to the next routine.

Lithium Battery Check (warning). In case of the lithium battery becomes low, the memory index LED blinks with 0 and 99, the 371B displays it and advances the diagnostic routines.

LED Check. The 371B sequentially lights all front panel LEDs for visual check.

Display Quality Check. This is second of two extended power-up diagnostic routines. When the extended power-up sequence reaches this test, the 371B displays a test pattern as shown in Figure C-1. The operator can use this test pattern as a template to align the display vertically and horizontally using the display ROTATION screwdriver adjustments. Use these adjustments to position the display as shown in Figure C-1.

The NON STORE/STORE/VIEW intensity control adjusts the intensity of the bright alignment dots. These dots are displayed at the center, outer corners, and mid-outer lines of the display graticule. The READOUT CURSOR intensity control adjusts the intensity of the double-line, dotted box. When the adjustment is finished, press cursor SHIFT to exit this routine.

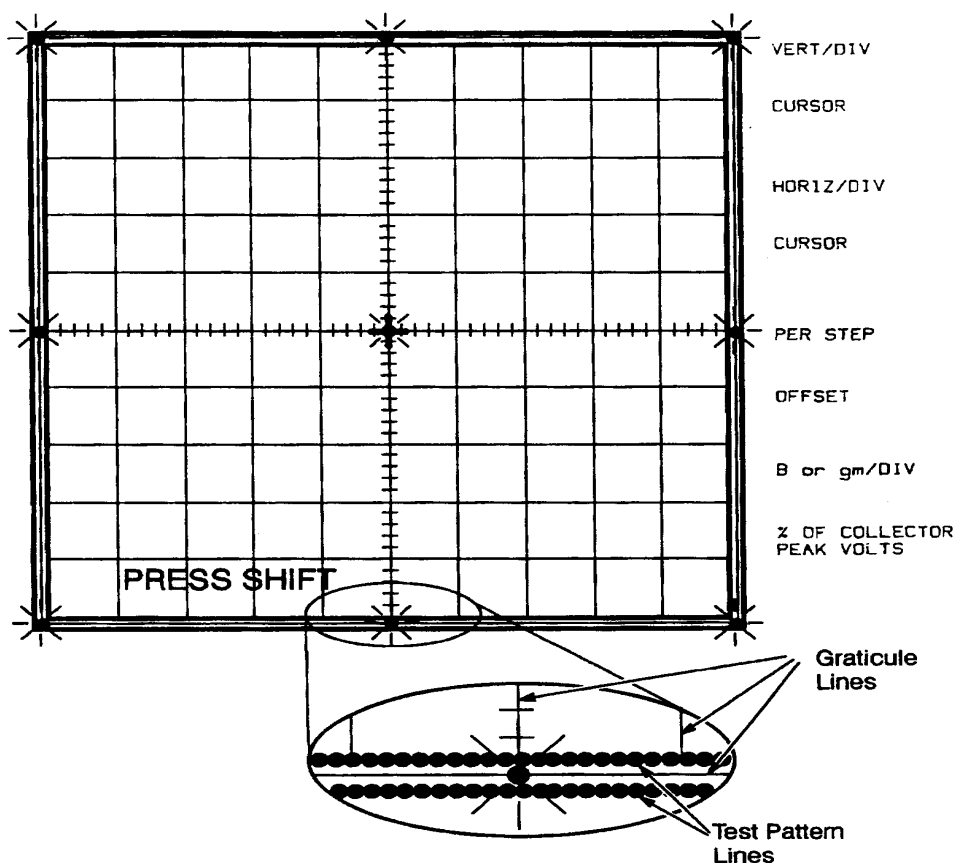

Figure C-1: Display quality test pattern

Key struck status test. The 371B executes this test. If an error is found, the error message is displayed on the CRT, pressing SHIFT button exits this routine.

Power Fail Interrupt. When the CPU detects power fail, the memory index LED displays 98, and the 371B shuts down with collector supply disabled. The POWER FAILED message will be appeared. The 371B will be disabled until power on.

CPU wait Interrupt. When the CPU detects acquisition timeout, the memory index LED blinks with 0 and 6, the 371B shuts down with collector supply disabled. The CPU WAIT ERROR message will be appeared.

Table C-1 shows the Power on System Error Messages displayed on the memory index display.

Table C-1: Power-on System Error Messages

Display	Description
0/1 (blink)	Boot ROM error (e.g., misinsertion)
0/2 (blink)	System RAM error (e.g., bus shorted)
0/3 (blink)	Display RAM Read/Write error (e.g., bus shorted)
0/4 (blink)	Acquisition RAM Read/Write error (e.g., bus shorted)
0/5 (blink)	Flash ROM checkSum error (e.g., bus shorted)
0/99 (blink)	Lithium battery is low (warning)

User Initiated Diagnostic Routine

Simultaneously pressing the SHIFT and NON STORE buttons enters the user-initiated diagnostic routine. This routine displays a message that corresponds to the front panel control that you have just operated. Thus, you can determine if the front panel controls are operating normally. Table C-2 lists the controls and the corresponding messages. To exit this routine, press both the SHIFT button and NON STORE button again.

Table C-2: Front Panel Control Identification

Control	Message
Display SAVE	SAVE
Display RECALL	RECALL
MEMORY up	MEMORY up
MEMORY down	MEMORY down
Display NON STORE	NON STORE
Display STORE	STORE
Display REF	REF
Display VIEW	VIEW
Display ENTER	ENTER
Display INVERT	INVERT
Measurement REPEAT	REPEAT
Measurement SINGLE	SINGLE

Table C-2: Front Panel Control Identification (Cont.)

Control	Message
Measurement SWEEP	SWEEP
GPIB RESET TO LOCAL	RESET TO LOCAL
GPIB USER REQUEST	USER REQUEST
HARD COPY	HARD COPY
CURSOR Mode up	CURSOR MODE up
CURSOR Mode down	CURSOR MODE down
CURSOR LEFT ARROW	CURSOR left
CURSOR RIGHT ARROW	CURSOR right
CURSOR UP ARROW	CURSOR up
CURSOR DOWN ARROW	CURSOR down
CURSOR SHIFT	SHIFT
Collector Supply POLARITY	POLARITY
MAX PEAK POWER WATTS 3 KW	3 KW
MAX PEAK POWER WATTS 300 W	300 W
MAX PEAK POWER WATTS 30 W	30 W
MAX PEAK POWER WATTS 3 W	3 W
Step Generator POLARITY INVERT	STEP INVERT
Step Generator CURRENT SOURCE	CURRENT
Step Generator VOLTAGE SOURCE	VOLTAGE
NUMBER OF STEPS up	# OF STEPS up
NUMBER OF STEPS down	# OF STEPS down
Step Generator OFFSET INCR	OFFSET up
Step Generator OFFSET DECR	OFFSET down
Step Generator MULTI .1X	STEP MULT
VERTICAL CURRENT/DIV	VERTICAL XX (0 - 16)
HORIZONTAL VOLTS/DIV	HORIZONTAL XX (0 - 16)
STEP/OFFSET AMPLITUDE	STEP AMP XX (0 - 16)
VARIABLE COLLECTOR SUPPLY	VARIABLE XX (0 - 25)
HIGH CURRENT OUTPUT: ON	H.C. ENABLED
HIGH CURRENT OUTPUT: OFF	H.C. DISABLED
HIGH VOLTAGE OUTPUT: ON	H.V. ENABLED
HIGH VOLTAGE OUTPUT: OFF	H.V. DISABLED
INTERLOCK: ON	INTERLOCK ON

Table C-2: Front Panel Control Identification (Cont.)

Control	Message
INTERLOCK: OFF	INTERLOCK OFF
GPIB ADDRESS/TERM	GPIB: n.term (n: 0 - 31, term = [EOI or LF/EOI])

GPIB Diagnostic Routine

The GPIB TEST? command initiates the 371B system ROMs and RAMs diagnostic routine. The 371B responds to this command by returning system ROM and RAM information to the controller as follows:

TEST ROM:000X, RAM:YYYY

Messages

The following is an alphabetical listing of 371B messages that can be displayed in the error message area of the display graticule.

Refer to Table C-1 and C-2 in Appendix C: Diagnostics for power-up system error messages and user-initiated push button messages.

Table C-3: Messages

Message	Description
CHECKSUM ERROR	Checksum error occurred in the mass storage system COL. RECOVERED is displayed. If the error persists, contact the qualified service person or the nearest Tektronix field service representative.
COL. FUSE BLOW	The collector supply fuse on the rear panel is blown.
COL. OVERHEAT	Series resistor (collector supply) overheat problem. Wait for COL. RECOVERED message. If the error persists, contact the nearest Tektronix field service representative.
COL. RECOVERED	The collector supply is recovered.
COPY CANCELED	Copy mode is canceled.
COPY COMPLETE	Data copying between floppy disk and non-volatile memory is completed.
COPYING CURVES	Characteristic curves are being copied.
COPYING SETUPS	Front-panel setups are being copied.
CPU WAIT ERROR	Internal control hardware errors. If the error persists, contact a qualified service person or the nearest Tektronix field service representative.
DISK FULL	There is no more room to write data on the disk.
ENTER COMPLETE	The displayed curve is saved in the mass storage memory.
ERASE CANCELED	Erasing the non-volatile memory is canceled.
ERASE COMPLETE	The non-volatile memory is erased.
FD DATA EMPTY	Floppy disk has no data in the file specified by the memory location number.
FD NOT READY	The floppy disk drive is not ready or floppy disk is not installed.
FORMAT ABORTED	Disk format is aborted.
FORMAT END	Disk formatting is complete.

Table C-3: Messages (Cont.)

Message	Description
FORMAT ERROR	Floppy disk system internal error. To determine whether FD the problem is in the floppy disk or in the disk drive, try a new disk. Attempt to save or recall a waveform or a setting. If the disk drive is at fault, contact the nearest Tektronix field service representative. However, you can still use the 371B, although internal floppy disk functions cannot be used.
FAULT	
FD READ ERROR	
FD SEEK ERROR	
FD WRITE ERROR	
H.C. DISABLED	HIGH CURRENT breaker is set to the DISABLED position.
H.C. ENABLED	HIGH CURRENT breaker is set to the ENABLED position.
H.C. UNMATCH	HIGH CURRENT breaker setting does not conform to saved setting at recall. Set the HIGH CURRENT breaker to conform with the save setting.
H.V/C UNMATCH	HIGH VOLTAGE breaker and HIGH CURRENT breaker setting do not conform to saved setting at recall. Set the HIGH VOLTAGE breaker and HIGH CURRENT breaker to conform to saved setting at recall.
H.V. DISABLED	HIGH VOLTAGE breaker is set to the DISABLED position.
H.V. ENABLED	HIGH VOLTAGE breaker is set to the ENABLED position.
H.V. UNMATCH	HIGH VOLTAGE breaker setting does not conform to saved setting at recall. Set the HIGH VOLTAGE breaker to conform with the saved setting.
INTERLOCK FAIL	Interlock system internal error. Contact the nearest Tektronix field service representative.
INVALID DATA	The data in the file specified by the memory location number is not valid.
NOW FORMATTING	The disk drive is formatting the disk.
NVM DATA EMPTY	Non-volatile memory has no data in the location specified by the memory location number.
NVM R/W ERROR	Non-volatile memory errors. Attempt to save or recall a waveform or a setting. If the error message persists, contact a Tektronix field representative. The 371B can still be used, although internal non-volatile memory functions cannot be used.
OPERATION ERR.	Operation error.
PLL UNLOCK	PLL(phaselocked loop) unlock.
PLOT ABORTED	Plotter output is aborted.
PLOT COMPLETE	Plotter output complete.
PLOT START	Plotter output is started.
SAVE COMPLETE	The current front-panel setting is saved in mass storage.
SELFTEST PASS	The 371B power-up diagnostic tests were successful.

Table C-3: Messages (Cont.)

Message	Description
SELFTEST START	The 371B has initiated the power-up diagnostic tests.
S.G. DISABLED	The step generator is disabled. Wait until the message S.G. RECOVERED is displayed. If the error persists, contact the nearest Tektronix field service representative.
S.G. RECOVERED	The step generator is recovered.
SWEEP COMPLETE	The waveform display in the sweep mode is completed.
TEXT CANCELED	Text edit mode is canceled; all text entered is lost.
TEXT EDIT MODE	Text can be entered on the CRT using the cursor position buttons(up, down, left, right).
WRITE PROTECT	The floppy disk is write protected. Set the disk write protect tab to the write enable position.

Appendix D: Inspection and Cleaning

Inspect and clean the instrument as often as operating conditions require. The collection of dirt can cause instrument overheating and breakdown. Dirt acts as an insulating blanket, preventing efficient heat dissipation. Dirt also provides an electrical conduction path that can cause an instrument failure, especially under high-humidity conditions.



CAUTION. To prevent damage avoid the use of chemical cleaning agents that might damage the plastics used in this instrument. Use only deionized water when cleaning the menu buttons or front-panel buttons. Use a ethyl alcohol solution as a cleaner and rinse with deionized water.

Avoid the use of high pressure compressed air when cleaning dust from the interior of this instrument. (High pressure air can cause ESD.) Instead, use low pressure compressed air (about 9 psi).

Inspection — Exterior

Using Table D-1 as a guide, inspect the outside of the instrument for damage, wear, and missing parts. You should thoroughly check instruments that appear to have been dropped or otherwise abused to verify correct operation and performance. Immediately repair defects that could cause personal injury or lead to further damage to the instrument.

Table D-1: External inspection check list

Item	Inspect for	Repair action
Cabinet, front panel, and cover	Cracks, scratches, deformations, damaged hardware or gaskets	Replace defective module
Front-panel knobs	Missing, damaged, or loose knobs	Repair or replace missing or defective knobs
Connectors	Broken shells, cracked insulation, and deformed contacts. Dirt in connectors	Replace defective modules; clear or wash out dirt
Carrying handle and cabinet feet	Correct operation	Replace defective module
Accessories	Missing items or parts of items, bent pins, broken or frayed cables, and damaged connectors	Replace damaged or missing items, frayed cables, and defective modules

**Cleaning Procedure —
Exterior**



WARNING. *To avoid injury or death, unplug the power cord from line voltage before cleaning the instrument. To avoid getting moisture inside the instrument during external cleaning, use only enough liquid to dampen the cloth or applicator.*

1. Remove loose dust on the outside of the instrument with a lint-free cloth.
2. Remove remaining dirt with a lint free cloth dampened in a general purpose detergent-and-water solution. Do not use abrasive cleaners.
3. Clean the monitor screen with a lint-free cloth dampened with either ethyl alcohol or, preferably, a gentle, general purpose detergent-and-water solution.

**Cleaning the
Instrument Interior**

Only qualified personnel should access the inside of the 371B Programmable High Power Curve Tracer for inspection and cleaning, refer to the Maintenance section in the 371B Programmable High Power Curve Tracer service manual.



Index

Index

A

- Address, Tektronix, 5
- ac input, 2–24
- accessories
 - optional, B–2
 - recommended, B–3
 - standard, B–2

B

- BGM? query, 4–47
- bmp file, 3–15

C

- cleaning, D–1
- cleaning, exterior, D–2
- Cleaning the Instrument Interior, D–2
- collector supply, 2–37
- COLLECTOR SUPPLY circuit breakers, 2–21
- Contacting Tektronix, 5
- cooling clearance, A–10
- copy
 - FD to NVM, 2–55
 - NVM to FD, 2–56
- CSOut? query, 4–39
- CSPol command, 4–40
- CSPol? query, 4–41
- csv file, 3–15
- CURRENT button, 2–15
- cursor, 2–47
 - dot, 2–48
 - f line, 2–48
 - window, 2–47
- CURSOr command, 4–52
- cursor controls, 2–11
- CURve command, 4–93
- CURve? query, 4–94

D

- date and time, 3–5
- DEBug command, 4–68
- DEBug? query, 4–69
- default settings, 3–3
- device connection, 2–32
- directory, 2–52

- display
 - store, 2–45
 - view, 2–45
- DISplay command, 4–60
- display mode, 2–45
 - non-store, 2–45
- DISplay? query, 4–61
- DOT command, 4–53
- dot cursor, 2–48
- DOT? query, 4–54

E

- ENTer command, 4–62
- ENTER/TEXT button, 2–8
- EVEnt? query, 4–84
- exercise
 - bipolar transistor measurement, 3–25
 - diode measurement, 3–18
 - display calibration, 3–6
 - display control, 3–4
 - power MOSFET measurement, 3–37
 - save/recall setups, 3–7
 - text edit, 3–11
 - vertical/horizontal controls, 3–8

F

- f line cursor, 2–48
- file directory, 2–52
- floppy disk, 2–58
 - format, 3–12
- floppy disk drive, 2–20
- FOCUS knob, 2–3

G

- diagnostics, C–6
 - power-up, C–1
 - user initiated, C–4
- GPIB
 - command reference, 4–33
 - communication protocol, 4–2
 - data storage and data transfer, 4–19
 - device dependent messages, 4–9
 - GPIB cable, 4–13
 - instrument setup, 4–17
 - interface messages, 4–7

- loading data from the controller, 4–23
- message format, 4–24
- moving waveform to the controller, 4–21
- power up, 4–14
- sending commands, 4–15
- sending queries, 4–16
- service requests, 4–100
- setting the bus address, 4–11

GPIB TERMINATOR and ADDRESS switch, 2–23
GRAT ILLUM knob, 2–3
GROUND CONNECTOR, 2–2

H

hardcopy, 3–15
HARDCOPY/BMP FILE button, 2–20
HELP? query, 4–70
HORiz command, 4–63
HORiz? query, 4–64
HORIZONTAL VOLTS/DIV control, 2–9

I

ID? query, 4–71
IEEE STD 488 PORT, 2–23
INIt command, 4–72
initial inspection, 1–6
inspection, D–1
inspection and cleaning, compressed air, D–1
installation, 1–6
interface characteristics, A–14
INVERT button, 2–9, 2–14

L

LINE command, 4–55
line fuse, 2–23
LINE? query, 4–56
LOOPING COMPENSATION control, 2–18

M

MEASURE command, 4–76
MEASURE? query, 4–77
measurement

- repeat mode, 2–39
- single mode, 2–40
- sweep mode, 2–40

measurement concepts, 1–5
measurement mode, 2–39
memory, 2–50

directory, 3–14
messages, C–7

N

NON STORE button, 2–7
NON STORE/STORE/VIEW knob, 2–3
non volatile memory, 2–55, 2–56

- erase, 2–57, 3–14

NUMBER OF STEPS button, 2–15

O

OFFSET button, 2–15
OPC command, 4–85
OPC? query, 4–86
options, B–1
OUTPUT ENABLED indicator, 2–21
OUTput? query, 4–78

P

patch cords, 1–3, 2–35
PEAK POWER WATTS buttons, 2–18
Phone number, Tektronix, 5
physical specification, A–9
PKPower command, 4–42
PKPower? query, 4–43
PLOt command, 4–79
POLARITY button, 2–17
POSITION knob, 2–3
POWER button, 2–2
power cord, 1–9
power source, specification, A–9
printer, B–3
PRINTER interface port, 2–23
product description, 1–1
Product support, contact information, 5
PStatus? query, 4–80

R

rackmount, 1–2, B–2
readout, 2–28

- message area, 2–28
- setup area, 2–28
- setup/curve id area, 2–29
- text area, 2–28

READout? query, 4–48
READOUT/CURSOR knob, 2–3
RECall command, 4–81

RECALL/DIRECTORY button, 2–4
 readout, 2–42
 curve display area, 2–43
 curve setup area, 2–42
 REF knob, 2–3
 REF/CAL OFF button, 2–8
 reference display mode, 2–46
 repacking for shipment, 1–13
 REPEAT button, 2–5
 RESET TO LOCAL/ADDR button, 2–19
 RQS command, 4–87
 RQS? query, 4–88

S

save and recall
 curve, 2–54
 settings, 2–53
 SAVe command, 4–82
 SAVE/FORMAT button, 2–4
 Service support, contact information, 5
 SET? query, 4–73
 SHIFT button, 2–13
 SINGLE button, 2–5
 specification, A–1
 certifications and compliances, A–12
 collector supply, A–1
 cooling clearance, A–10
 CRT and readout, A–8
 digital storage acquisition, A–6
 environmental, A–10
 horizontal deflection, A–6
 installation category and pollution degree, A–13
 performance conditions, A–1
 physical, A–9
 power requirements, A–9
 power source, A–9
 step generator, A–3
 surge current, A–9
 vertical deflection system, A–6
 step generator, 2–38
 STEP MULTI .1X/DISABLED button, 2–15
 STEP/OFFSET AMPLITUDE control, 2–16
 storage, 2–50
 STORE/CAL FULL button, 2–7
 STPgen command, 4–90

STPgen? query, 4–91
 SWEEP button, 2–6

T

Technical support, contact information, 5
 Tektronix, contacting, 5
 test adapters, 1–3, 2–33
 test fixture, 2–25
 interlock, 1–4
 test fixture connector, 2–22
 test fixture unit, 1–3
 TEST? query, 4–74
 TEXT command, 4–49
 text editing, 2–48
 TEXT? query, 4–50
 TRACE ROTATION control, 2–3

U

USER REQUEST/ID button, 2–20
 URL, Tektronix, 5

V

VARIABLE knob, 2–18
 VCSpplly command, 4–44
 VCSpplly? query, 4–45
 VERt command, 4–65
 VERt? query, 4–66
 VERTICAL CURRENT/DIV control, 2–9
 VIEW/CAL ZERO button, 2–8
 VOLTAGE button, 2–15

W

WAVfrm? query, 4–95
 Web site address, Tektronix, 5
 WFMpre command, 4–96
 WFMpre NR.PT command, 4–98
 WFMpre? NR.PT query, 4–99
 WFMpre? query, 4–97
 WINdow command, 4–57
 window cursor, 2–47
 WINdow? query, 4–58

